

# EZ-ZONE<sup>®</sup> PM

---

## User's Manual



## PID Controller Models



**ISO 9001**



Registered Company  
Winona, Minnesota USA

1241 Bundy Boulevard., Winona, Minnesota USA 55987  
Phone: +1 (507) 454-5300, Fax: +1 (507) 452-4507 <http://www.watlow.com>

---

0600-0058-0000 Rev. J

Made in the U.S.A.



March 2010

## Safety Information







We use note, caution and warning symbols throughout this book to draw your attention to important operational and safety information.







A “NOTE” marks a short message to alert you to an important detail.

A “CAUTION” safety alert appears with information that is important for protecting your equipment and performance. Be especially careful to read and follow all cautions that apply to your application.

A “WARNING” safety alert appears with information that is important for protecting you, others and equipment from damage. Pay very close attention to all warnings that apply to your application.

The electrical hazard symbol, ⚡ (a lightning bolt in a triangle) precedes an electric shock hazard CAUTION or WARNING safety statement.

Symbol	Explanation
	CAUTION – Warning or Hazard that needs further explanation than label on unit can provide. Consult users manual for further information.
	ESD Sensitive product, use proper grounding and handling techniques when installing or servicing product.
	Unit protected by double/reinforced insulation for shock hazard prevention.
	Do not throw in trash, use proper recycling techniques or consult manufacturer for proper disposal.
	Enclosure made of Polycarbonate material. Use proper recycling techniques or consult manufacturer for proper disposal.
	Unit can be powered with either alternating current (ac) voltage or direct current (dc) voltage.
	Unit is a Listed device per Underwriters Laboratories®. It has been evaluated to United States and Canadian requirements for Process Control Equipment. UL 61010 and CSA C22.2 No. 61010. File E185611 QUYX, QUYX7. See: <a href="http://www.ul.com">www.ul.com</a>

	Unit is a Listed device per Underwriters Laboratories®. It has been evaluated to United States and Canadian requirements for Hazardous Locations Class 1 Division II Groups A, B, C and D. ANSI/ISA 12.12.01-2007. File E184390 QUZW, QUZW7. See: <a href="http://www.ul.com">www.ul.com</a>
	Unit is compliant with European Union directives. See Declaration of Conformity for further details on Directives and Standards used for Compliance.
	Unit has been reviewed and approved by Factory Mutual as a Temperature Limit Device per FM Class 3545 standard. See: <a href="http://www.fmglobal.com">www.fmglobal.com</a>
	Unit has been reviewed and approved by CSA International for use as Temperature Indicating-Regulating Equipment per CSA C22.2 No. 24. See: <a href="http://www.csa-international.org">www.csa-international.org</a>
	Unit has been reviewed and approved by ODVA for compliance with DeviceNet communications protocol. See: <a href="http://www.odva.org">www.odva.org</a>
	Unit has been reviewed and approved by ODVA for compliance with Ethernet/IP communications protocol. See: <a href="http://www.odva.org">www.odva.org</a>

## Warranty

The EZ-ZONE® PM is manufactured by ISO 9001-registered processes and is backed by a three-year warranty to the first purchaser for use, providing that the units have not been misapplied. Since Watlow has no control over their use, and sometimes misuse, we cannot guarantee against failure. Watlow’s obligations hereunder, at Watlow’s option, are limited to replacement, repair or refund of purchase price, and parts which upon examination prove to be defective within the warranty period specified. This warranty does not apply to damage resulting from transportation, alteration, misuse or abuse. The purchaser must use Watlow parts to maintain all listed ratings.

## Technical Assistance

If you encounter a problem with your Watlow controller, review your configuration information to verify that your selections are consistent with your application: inputs, outputs, alarms, limits, etc. If the problem persists, you can get technical assistance from your local Watlow representative (see back cover), by e-mailing your questions to [wintechsupport@watlow.com](mailto:wintechsupport@watlow.com) or by dialing +1 (507) 494-5656 between 7 a.m. and 5 p.m., Central Standard Time (CST). Ask for for an Applications Engineer. Please have the following information available when calling:

- Complete model number

- All configuration information
- User's Manual
- Factory Page

### **Return Material Authorization (RMA)**

1. Call Watlow Customer Service, (507) 454-5300, for a Return Material Authorization (RMA) number before returning any item for repair. If you do not know why the product failed, contact an Application Engineer or Product Manager. All RMA's require:
  - Ship-to address
  - Bill-to address
  - Contact name
  - Phone number
  - Method of return shipment
  - Your P.O. number
  - Detailed description of the problem
  - Any special instructions
  - Name and phone number of person returning the product.
2. Prior approval and an RMA number from the Customer Service Department is required when returning any product for credit, repair or evaluation. Make sure the RMA number is on the outside of the carton and on all paperwork returned. Ship on a Freight Prepaid basis.
3. After we receive your return, we will examine it and try to verify the reason for returning it.
4. In cases of manufacturing defect, we will enter a repair order, replacement order or issue credit for material returned. In cases of customer mis-use, we will provide repair costs and request a purchase order to proceed with the repair work.
5. To return products that are not defective, goods must be in new condition, in the original boxes and they must be returned within 120 days of receipt. A 20 percent restocking charge is applied for all returned stock controls and accessories.
6. If the unit is unrepairable, you will receive a letter of explanation. and be given the option to have the unit returned to you at your expense or to have us scrap the unit.
7. Watlow reserves the right to charge for no trouble found (NTF) returns.

The EZ-ZONE® PM PID Controller User's Manual is copyrighted by Watlow Winona, Inc., © March 2010 with all rights reserved.

EZ-ZONE® PM is covered by U.S. Patent No. 6,005,577 and Patents Pending



# Table of Contents

- Chapter 1: Overview . . . . . 3**
  - Standard Features and Benefits . . . . . 3
  - A Conceptual View of the PM . . . . . 4
  - Getting Started Quickly . . . . . 5
- Chapter 2: Install and Wire . . . . . 7**
  - Dimensions . . . . . 7
  - Installation . . . . . 12
  - Wiring . . . . . 14
- Chapter 3: Keys and Displays . . . . . 26**
- Chapter 4: Home Page . . . . . 28**
  - Conventions Used in the Menu Pages . . . . . 31
- Chapter 5: Operations Page . . . . . 33**
  - Analog Input Menu . . . . . 34
  - Linearization Menu . . . . . 34
  - Process Value Menu . . . . . 35
  - Digital Input/Output Menu . . . . . 36
  - Monitor Menu . . . . . 36
  - Control Loop Menu . . . . . 37
  - Alarm Menu . . . . . 39
  - Profile Status Menu . . . . . 40
- Chapter 6: Setup Page . . . . . 43**
  - Analog Input Menu . . . . . 45
  - Linearization Menu . . . . . 46
  - Process Value Menu . . . . . 48
  - Digital Input/Output Menu . . . . . 49
  - Control Loop Menu . . . . . 52
  - Output Menu . . . . . 55
  - Alarm Menu . . . . . 57
  - Function Key Menu . . . . . 59
  - Global Menu . . . . . 60
  - Communications Menu . . . . . 62
  - Real Time Clock Menu . . . . . 63



# Table of Contents (cont.)

<b>Chapter 7: Profiling Page</b> .....	<b>64</b>
Profiling Menu .....	65
<b>Chapter 8: Factory Page</b> .....	<b>68</b>
Custom Menu .....	69
Security Setting Menu .....	69
Security Setting Menu .....	71
Diagnostics Menu .....	71
Calibration Menu .....	71
<b>Chapter 9: Features</b> .....	<b>73</b>
Saving and Restoring User Settings .....	74
Programming the Home Page .....	74
Tuning the PID Parameters .....	74
Inputs .....	76
Outputs .....	77
Control Methods .....	79
Alarms .....	82
Open Loop Detection .....	83
Programming the EZ Key/s .....	84
Using Lockout to Hide Pages and Menus .....	84
Using Password Security .....	85
Modbus - Using Programmable Memory Blocks .....	86
Software Configuration .....	87
<b>Chapter 10: Appendix</b> .....	<b>90</b>
Troubleshooting Alarms, Errors and Control Issues .....	90
Modbus - Programmable Memory Blocks .....	93
Specifications .....	95
Ordering Information for PID Controller Models .....	97
Index .....	98
How to Reach Us .....	103

# 1

## Chapter 1: Overview

The EZ-ZONE® PM takes the pain out of solving your thermal loop requirements.

Watlow's EZ-ZONE PM controllers offer options to reduce system complexity and the cost of control-loop ownership. You can order the EZ-ZONE PM as a PID controller or an over-under limit controller, or you can combine both functions in the PM Integrated Limit Controller. You now have the option to integrate a high-amperage power controller output, an over-under limit controller and a high-performance PID controller all in space-saving, panel-mount packages. You can also select from a number of serial communications options to help you manage system performance.

It just got a whole lot easier to solve the thermal requirements of your system. Because the EZ-ZONE PM controllers are highly scalable, you only pay for what you need. So if you are looking for a PID controller, an over-under limit controller or an integrated controller, the EZ-ZONE PM is the answer.

### Standard Features and Benefits

#### Advanced PID Control Algorithm

- TRU-TUNE+® Adaptive tune provides tighter control for demanding applications.
- Auto Tune for fast, efficient start ups

#### High-amperage Power Control Output

- Drives 15 amp resistive loads directly
- Reduces component count
- Saves panel space and simplifies wiring
- Reduces the cost of ownership

#### EZ-ZONE configuration communications and software

- Saves time and improves the reliability of controller set up

#### Parameter Save & Restore Memory

- Reduces service calls and down time

#### Agency approvals: UL Listed, CSA, CE, RoHS, W.E.E.E. FM

- Assures prompt product acceptance
- Reduces end product documentation costs
- Semi F47-0200

#### P3T Armor Sealing System

- NEMA 4X and IP66 offers water and dust resistance, can be cleaned and washed down (indoor use only)
- Backed up by UL 50 independent certification to NEMA 4X specification

#### Three-year warranty

- Demonstrates Watlow's reliability and product support

#### Touch-safe Package

- IP2X increased safety for installers and operators

#### Removable cage clamp wiring connectors

- Reliable wiring, reduced service calls
- Simplified installation

#### EZ-Key/s

- Programmable EZ-Key enables simple one-touch operation of repetitive user activities

#### Programmable Menu System

- Reduces set up time and increases operator efficiency

#### Full-featured Alarms

- Improves operator recognition of system faults
- Control of auxiliary devices

#### Heat-Cool Operation

- Provides application flexibility with accurate temperature and process control

#### Profile Capability

- Preprogrammed process control
- Ramp and soak programming with four files and 40 total steps

## A Conceptual View of the PM

The flexibility of the PM's software and hardware allows a large range of configurations. Acquiring a better understanding of the controller's overall functionality and capabilities while at the same time planning out how the controller can be used will deliver maximum effectiveness in your application.

It is useful to think of the controller in three parts: inputs; procedures; and outputs. Information flows from an input to a procedure to an output when the controller is properly configured. A single PM controller can carry out several procedures at the same time, for instance closed-loop control, monitoring for several different alarm situations and operating switched devices, such as lights and motors. Each process needs to be thought out carefully and the controller's inputs, procedures and outputs set up properly.

### Inputs

The inputs provide the information that any given programmed procedure can act upon. In a simple form, this information may come from an operator pushing a button or as part of a more complex procedure it may represent a remote set point being received from another controller.

Each analog input typically uses a thermocouple or RTD to read the temperature of something. It can also read volts, current or resistance, allowing it to use various devices to read humidity, air pressure, operator inputs and others values. The settings in the Analog Input Menu (Setup Page) for each analog input must be configured to match the device connected to that input.

Each digital input reads whether a device is active or inactive. A PM with digital input-output hardware includes two sets of terminals each of which can be used as either an input or an output. Each pair of terminals must be configured to function as either an input or output with the Direction parameter in the Digital Input/Output Menu (Setup Page).

The Function or EZ Key on the front panel of the PM also operates as a digital input by toggling the function assigned to it in the Digital Input Function parameter in the Function Key Menu (Setup Page).

### Functions

Functions use input signals to calculate a value. A function may be as simple as reading a digital input to set a state to true or false, or reading a temperature to set an alarm state to on or off. Or, it could compare the temperature of a process to the set point and calculate the optimal power for a heater.

To set up a function, it's important to tell it what source, or instance, to use. For example, an alarm may be set to respond to either analog input 1 or 2 (instance 1 or 2, respectively).

Keep in mind that a function is a user-programmed internal process that does not execute any action out-

side of the controller. To have any effect outside of the controller, an output must be configured to respond to a function.

### Outputs

Outputs can perform various functions or actions in response to information provided by a function, such as operating a heater; turning a light on or off; unlocking a door; or turning on a buzzer.

Assign an output to a Function in the Output Menu or Digital Input/Output Menu. Then select which instance of that function will drive the selected output. For example, you might assign an output to respond to alarm 4 (instance 4) or to retransmit the value of analog input 2 (instance 2).

You can assign more than one output to respond to a single instance of a function. For example, alarm 2 could be used to trigger a light connected to output 1 and a siren connected to digital output 5.

### Input Events and Output Events

Input and output events are internal states that are used exclusively by profiles. The source of an event input can come from a real-world digital input or an output from another function. Likewise, event outputs may control a physical output such as an output function block or be used as an input to another function.

## Getting Started Quickly

The PM control has a page and menu structure that is listed below along with a brief description of its purpose.

<p><b>Setup Page</b> Push and hold the up and down keys (▲ ▼) for 6 seconds to enter. (See the <a href="#">Setup Page</a> for further information)</p>	<p>Once received, a user would want to setup their control prior to operation. As an example, define the input type and set the output cycle time.</p>
<p><b>Operations Page</b> Push and hold the up and down keys (▲ ▼) for 3 seconds to enter. (See the <a href="#">Operations Page</a> for further information)</p>	<p>After setting up the control to reflect your equipment, the Operations Page would be used to monitor or change runtime settings. As an example, the user may want to see how much time is left in a profile step or perhaps change the autotune set point.</p>
<p><b>Factory Page</b> Push and hold the Infinity and the green Advance keys (∞ ⏻) for 6 seconds to enter. (See the <a href="#">Factory Page</a> for further information)</p>	<p>For the most part the Factory Page has no bearing on the control when running. A user may want to enable password protection, view the control part number or perhaps create a custom Home Page.</p>
<p><b>Home Page</b> The control is at the <a href="#">Home Page</a> when initially powered up.</p>	<p>Pushing the green Advance key ⏻ will allow the user to see and change such parameters as the control mode, enable autotune and idle set point to name a few.</p>
<p><b>Profile Page</b> Push and hold the the green Advance key ⏻ for 6 seconds to enter. (See the <a href="#">Profile Page</a> for further information)</p>	<p>If equipped with this feature a user would want to go here to configure a profile.</p>

The default PM loop configuration out of the box is shown below:

- Analog Input functions set to thermocouple, type J
- Heat algorithm set for PID, Cool set to off
- Output 1 set to Heat
- Control mode set to Auto
- Set point set to 75 °F

If you are using the input type shown above, simply connect your input and output devices to the control. Power up the control and push the up arrow ▲ on the face of the control to change the set point from

the default value of 75 °F to the desired value. As the Set Point increases above the Process Value, output 1 will come on and it will now begin driving your output device. The PV function as shown in the graphic below is only available with PM4/8/9 models.

### Note:

The output cycle time will have a bearing on the life of mechanical relay outputs and can be different based on the type of output ordered. The output cycle time can be changed in the Setup Page under the Output Menu.

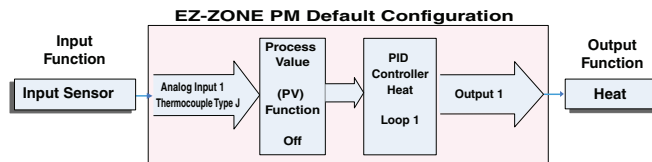



# EZ-ZONE® PM PID Model System Diagram

Universal Sensor Input, Configuration Communications,  
Red/Green 7-Segment Display

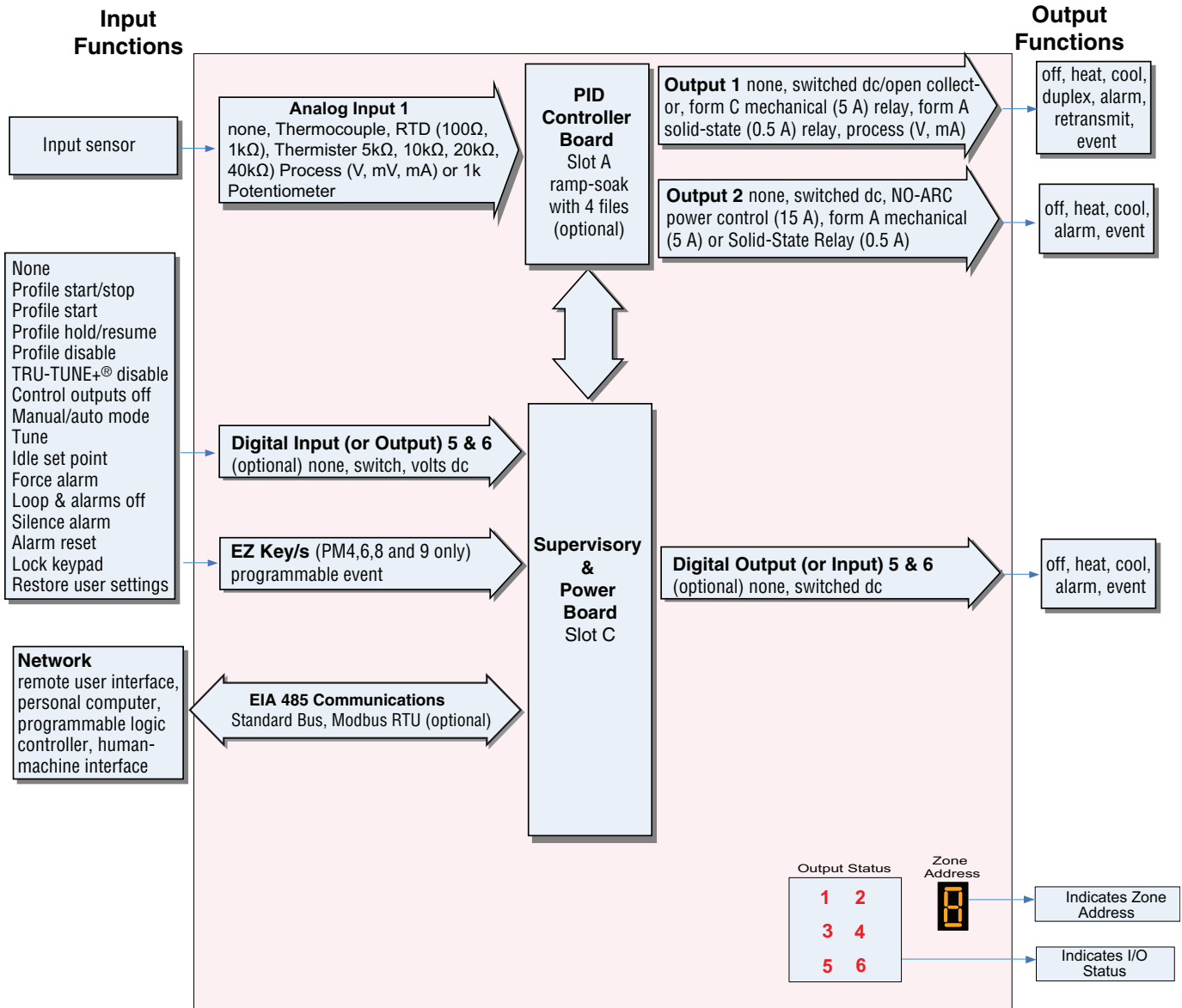

# 2

## Chapter 2: Install and Wire

### Dimensions

#### 1/32 DIN

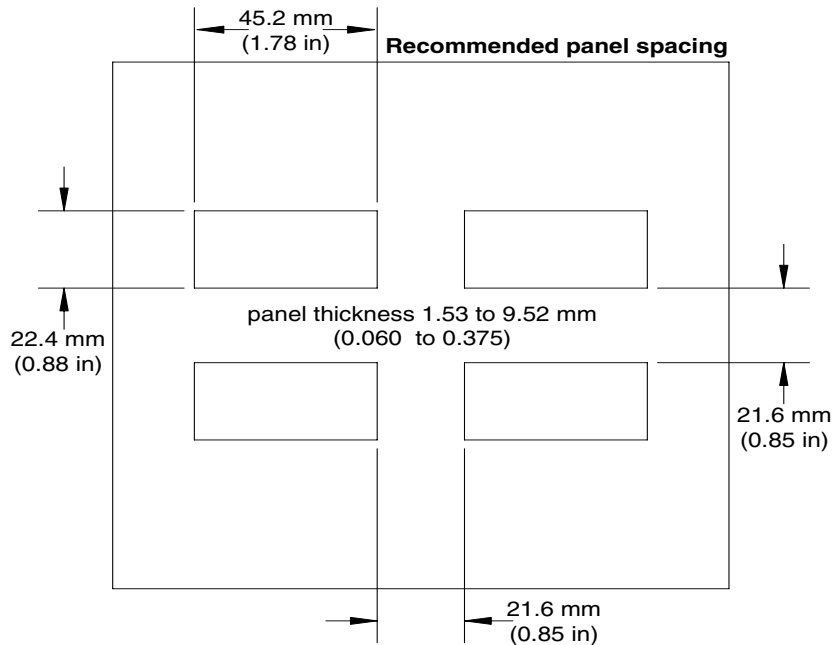
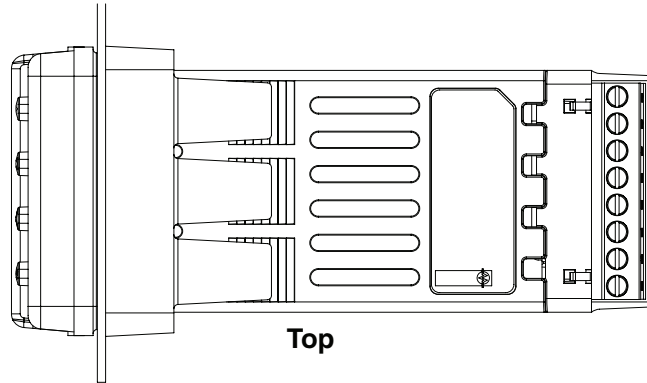
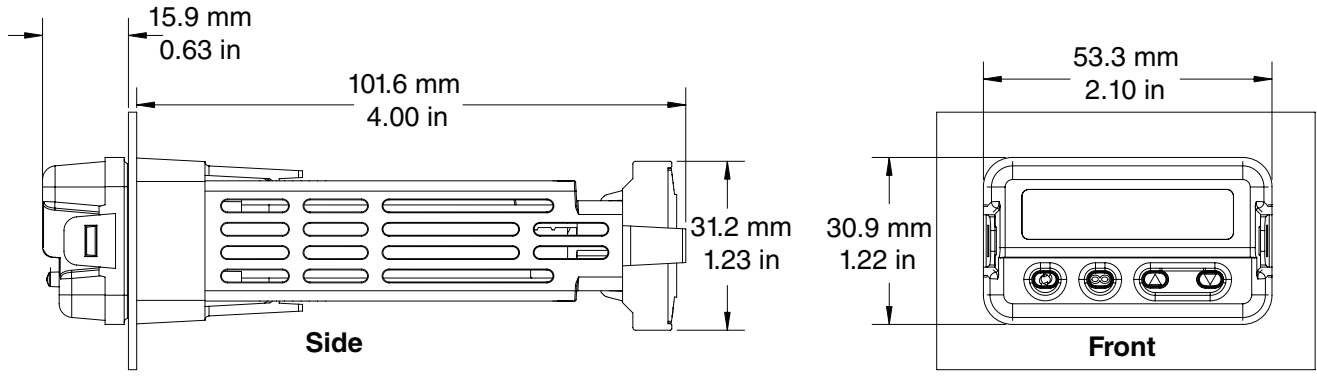

# 1/16 DIN

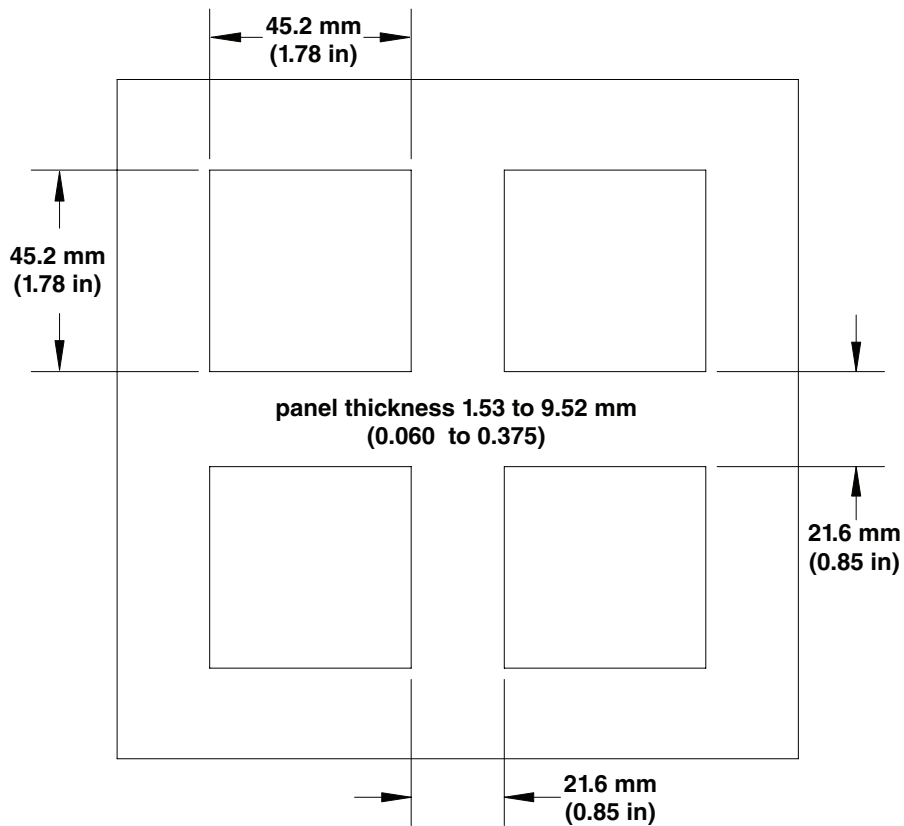
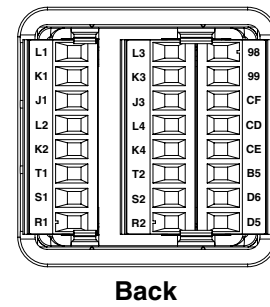
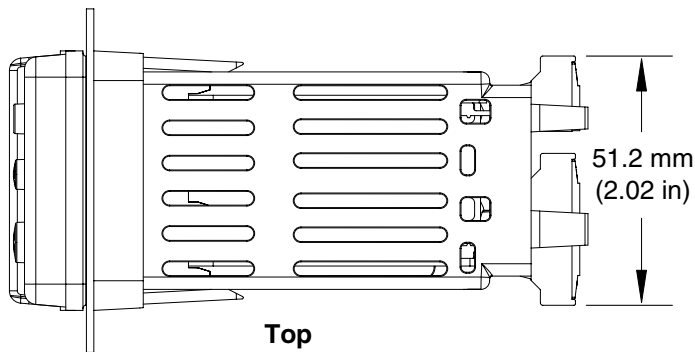
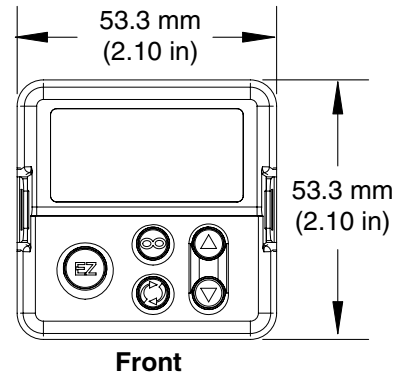
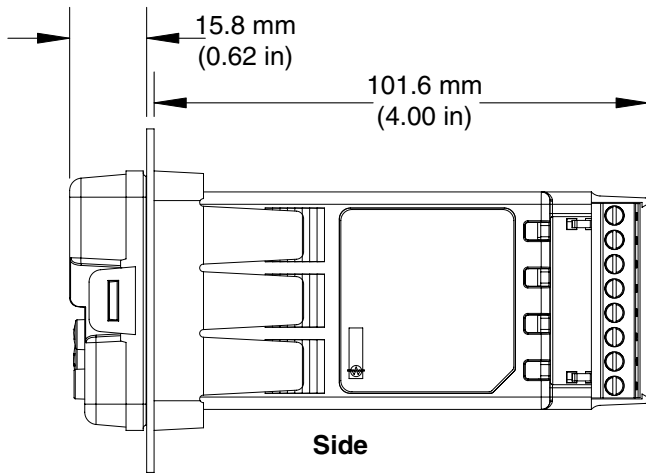

## 1/8 DIN (PM8) Vertical

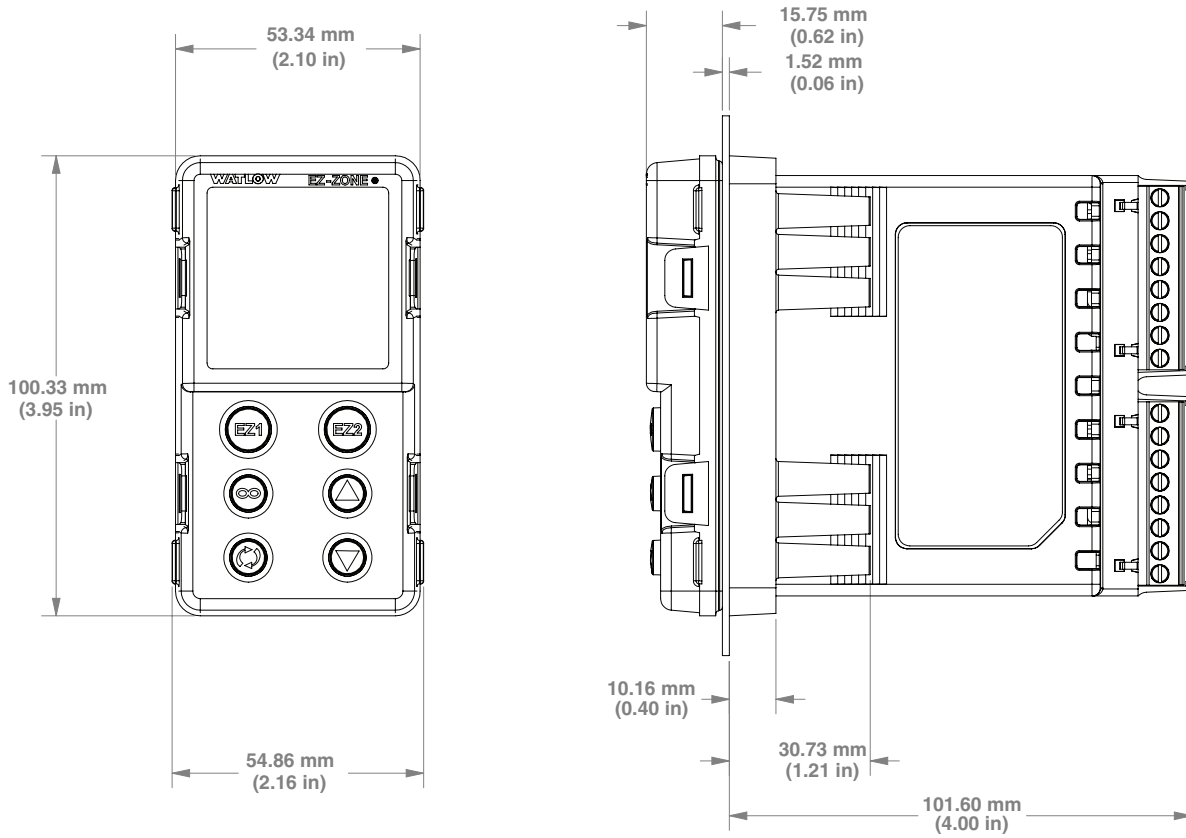

## 1/8 DIN (PM8) Vertical Recommended Panel Spacing

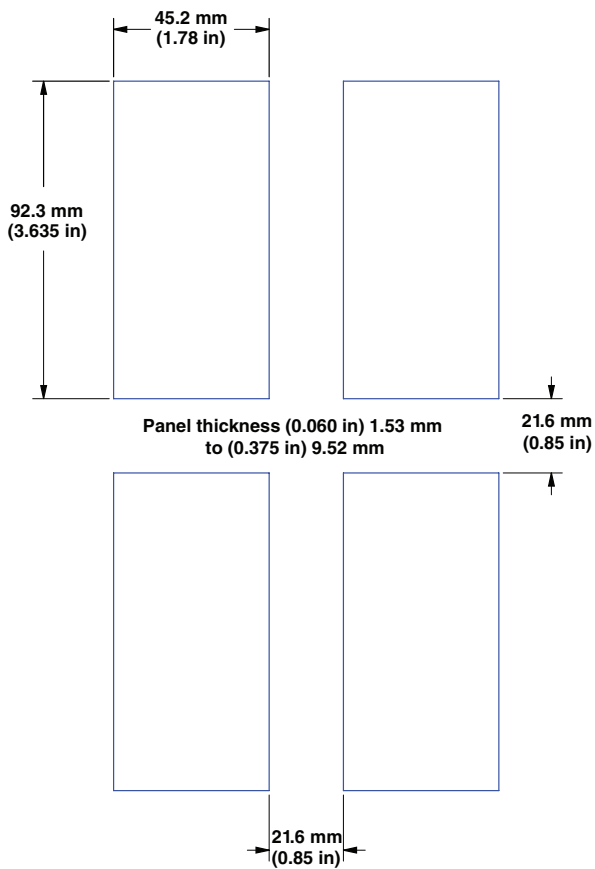

## 1/8 DIN (PM9) Horizontal

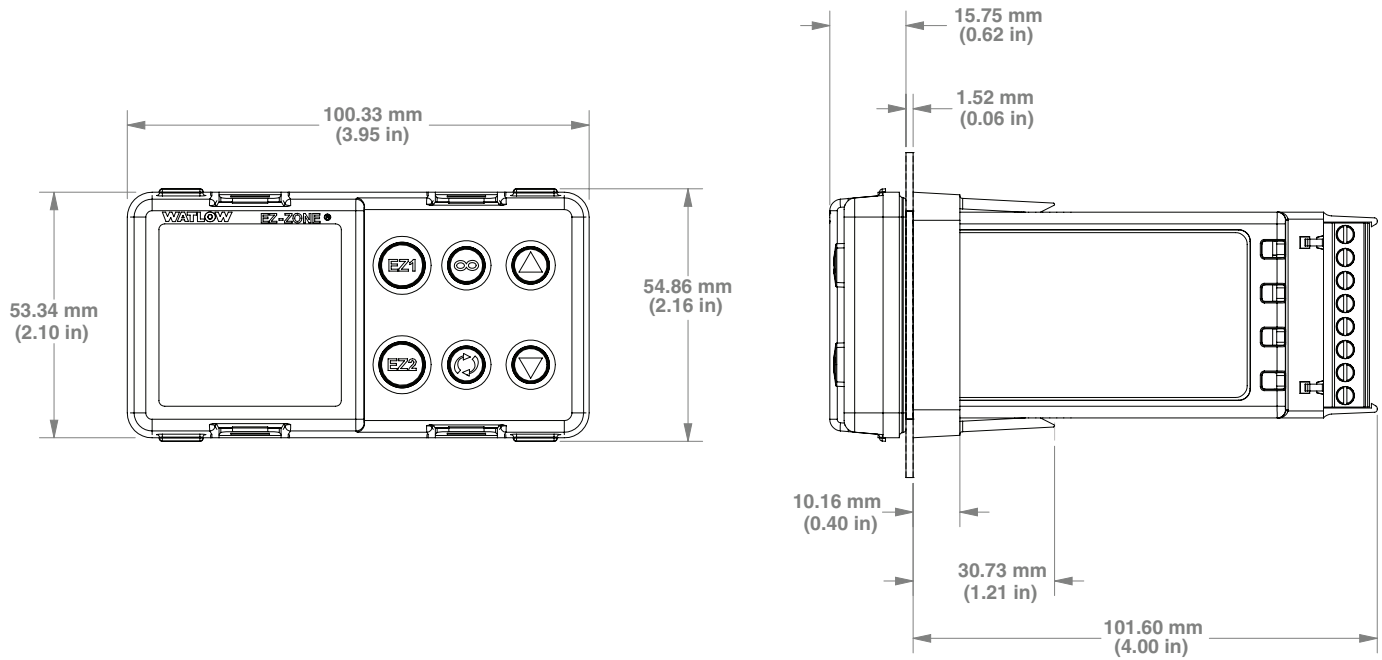

## 1/8 DIN (PM9) Horizontal Recommended Panel Spacing

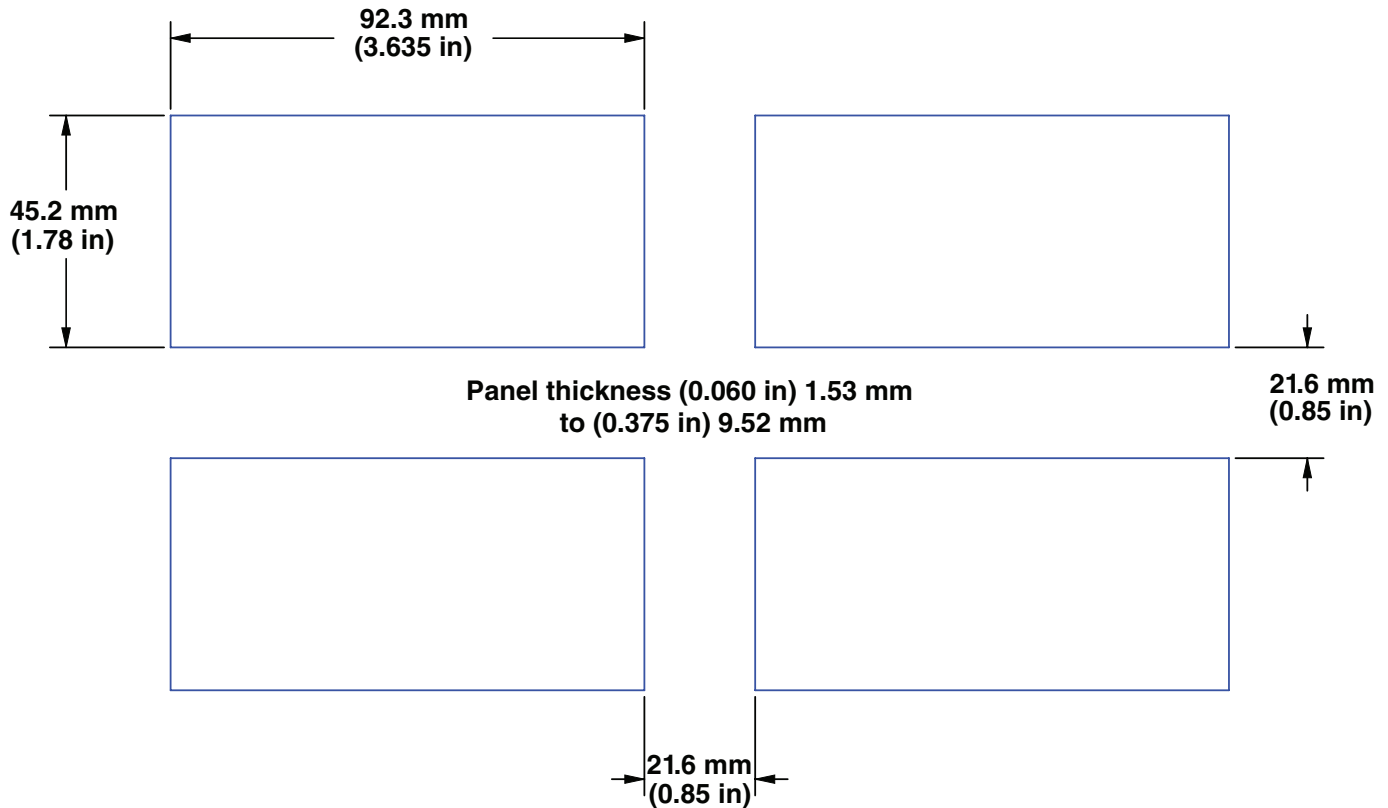

# 1/4 DIN (PM4)

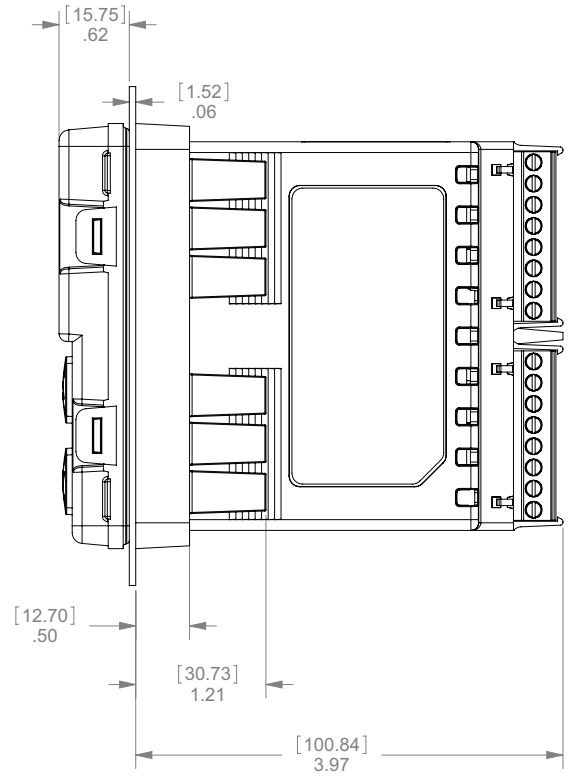
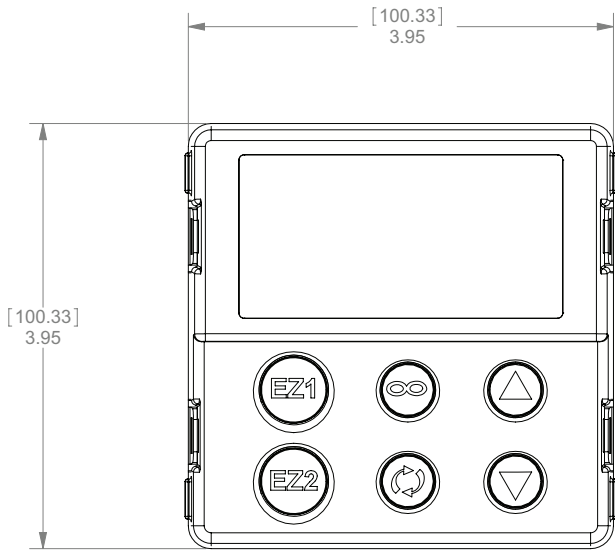

## 1/4 DIN (PM4) Recommended Panel Spacing

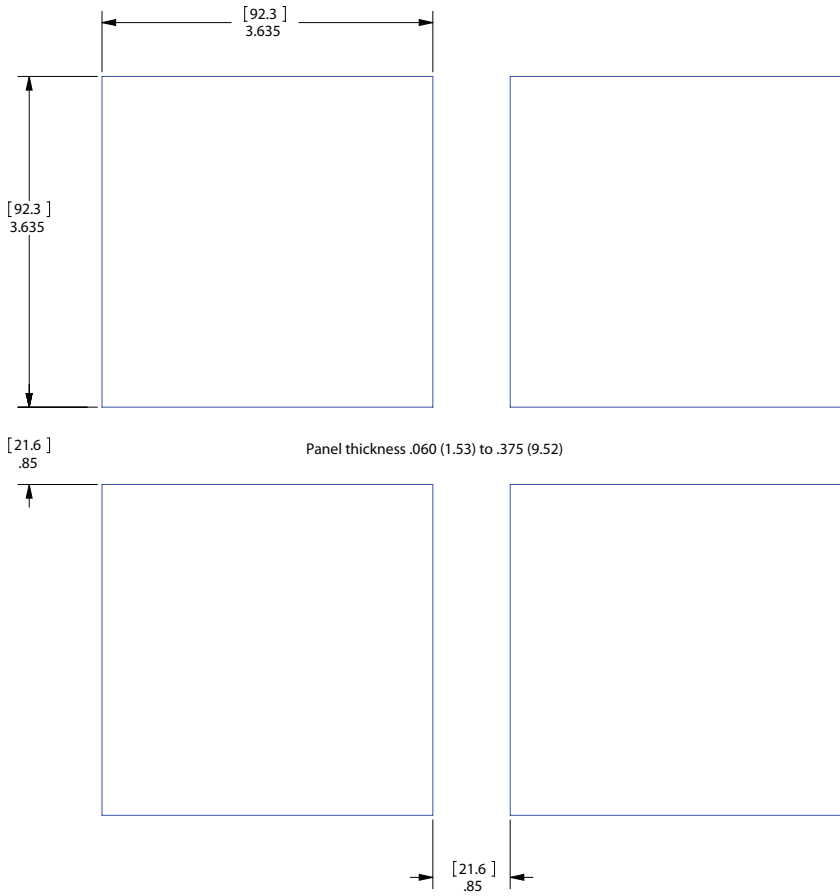

# Installation

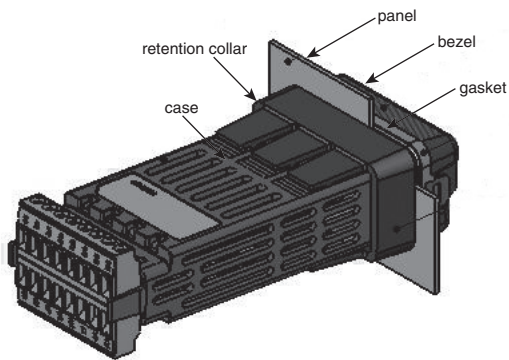
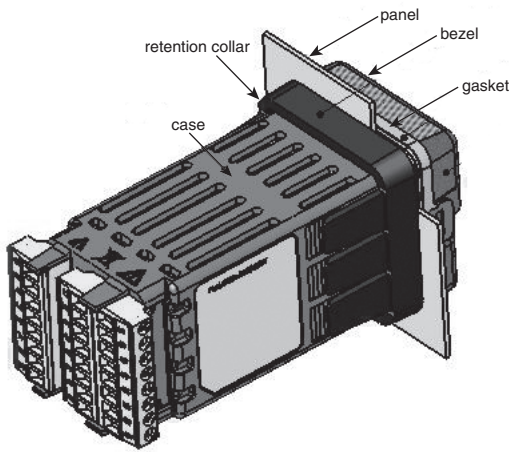

1. Make the panel cutout using the mounting template dimensions in this chapter.  
Insert the case assembly into the panel cutout.
2. While pressing the case assembly firmly against the panel, slide the mounting collar over the back of the controller.  
If the installation does not require a NEMA 4X seal, simply slide together until the gasket is compressed.

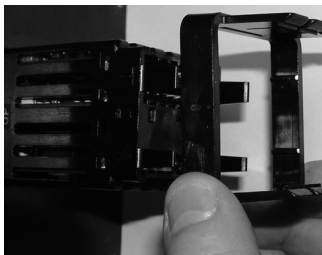

Slide the mounting collar over the back of the controller.

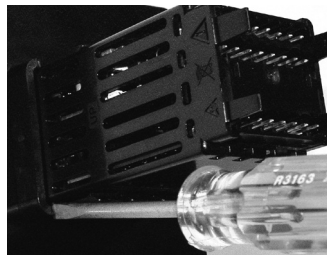

Place the blade of a screwdriver in the notch of the mounting collar assembly.

3. For a NEMA 4X (UL50, IP66) seal, alternately place and push the blade of a screwdriver against each of the the four corners of the mounting collar assembly. Apply pressure to the face of the controller while pushing with the screwdriver.

Don't be afraid to apply enough pressure to properly install the controller. The seal system is compressed more by mating the mounting collar tighter to the front panel (see pictures above). If you can move the case assembly back and forth in the cutout, you do not have a proper seal.

The tabs on each side of the mounting collar have teeth that latch into the ridges on the sides of the controller. Each tooth is staggered at a different depth from the front so that only one of the tabs, on each side, is locked onto the ridges at a time.

## Note:

There is a graduated measurement difference between the upper and lower half of the display to the panel. In order to meet the seal requirements mentioned above, ensure that the distance from the front of the top half of the display to the panel is 16 mm (0.630 in.) or less, and the distance from the front of the bottom half and the panel is 13.3 mm (0.525 in.) or less.

## Removing the Mounted Controller from Its Case

1. From the controller's face, pull out the tabs on each side until you hear it click.



Pull out the tab on each side until you hear it click.



Grab the unit above and below the face and pull forward.

2. On a PM6 control once the sides are released grab the unit above and below the face with two hands and pull the unit out. On the PM4/8/9 controls slide a screwdriver under the pry tabs and turn.

## Warning:

- This equipment is suitable for use in class 1, div. 2, Groups A, B, C and D or Non-Hazardous locations only. Temperature Code T4A.
- WARNING – EXPLOSION HAZARD. Substitution of component may impair suitability for class 1, div. 2.
- WARNING – EXPLOSION HAZARD. Do not disconnect equipment unless power has been switched off or the area is known to be nonhazardous.

## Returning the Controller to its Case

1. Ensure that the orientation of the controller is correct and slide it back into the housing.

**Note: The controller is keyed so if it feels that it will not slide back in do not force it. Check the orientation again and reinsert after correcting.**

2. Using your thumbs push on either side of the controller until both latches click.

## Chemical Compatibility

This product is compatible with acids, weak alkalis, alcohols, gamma radiation and ultraviolet radiation.

This product is not compatible with strong alkalis, organic solvents, fuels, aromatic hydrocarbons, chlorinated hydrocarbons, esters and ketones.



### Warning:

All electrical power to the controller and controlled circuits must be disconnected before removing the controller from the front panel or disconnecting other wiring.

Failure to follow these instructions may cause an electrical shock and/or sparks that could cause an explosion in class 1, div. 2 hazardous locations.



# Wiring

## Terminal Definitions for Slots A

Slot A			
Output	Terminal Function		Configuration
1	2		
X1 W1 Y1	common (Any switched dc output can use this common.) dc- (open collector) dc+		Switched dc/open collector output 1: PM ___ C _- AAAA _-
	W2 Y2	dc- dc+	Switched dc output 2: PM ___ C- AAAA _-
F1 G1 H1	voltage or current - voltage + current +		Universal Process output 1: PM ___ F _- AAAA _-
L1 K1 J1	normally open common normally closed		Mechanical Relay 5 A, Form C output 1: PM ___ E _- AAAA _-
	L2 K2	normally open common	NO-ARC 15 A, Form A output 2: PM[4, 6, 8, 9] ___ H- AAAA _-
	L2 K2	normally open common	Mechanical Relay 5 A, Form A output 2: PM ___ J- AAAA _-
L1 K1	L2 K2	normally open common	Solid-state Relay 0.5 A, Form A output 1: PM ___ K _- AAAA _- output 2: PM ___ K- AAAA _-
<b>Inputs</b>			
1			
T1 S1 R1	S2 (RTD) or current + S3 (RTD), thermocouple -, current -, volts - or potentiometer wiper, thermistor S1 (RTD), thermocouple + or volts +, thermistor		Universal / Thermistor Input input 1: all configurations
Slot A			

## Terminal Definitions for Slot C

Slot C	Terminal Function	Configuration
98 99	power input: ac or dc+ power input: ac or dc-	all
CC CA CB	Standard Bus or Modbus RTU EIA-485 common Standard Bus or Modbus RTU EIA-485 T-/R- Standard Bus or Modbus RTU EIA-485 T+/R+	Standard Bus or Modbus PM ___ -1 AAAA _-
CF CD CE	Standard Bus EIA-485 common Standard Bus EIA-485 T-/R- Standard Bus EIA-485 T+/R+	PM ___ -A AAAA _-
B5 D6 D5	digital input-output common digital input or output 6 digital input or output 5	PM ___ 2 _- AAAA _- PM ___ 4 _- AAAA _-

**Back View  
Slot Orientation  
1/16 DIN PM6**

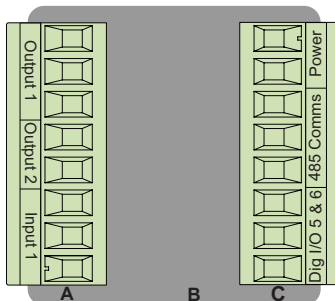

**Back View  
Slot Orientation  
1/32 DIN PM3**

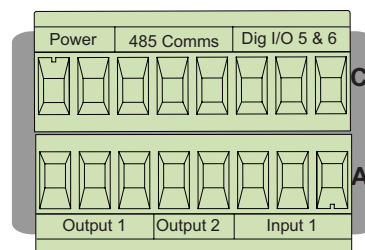

**Back View  
Slot Orientation 1/8  
DIN Vertical PM8**

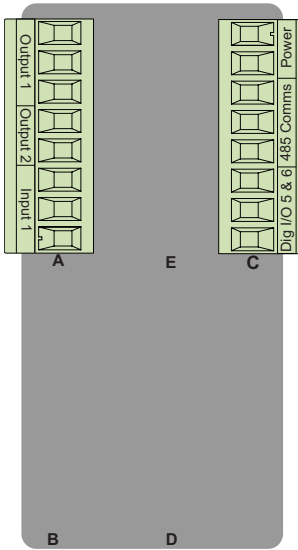

**Back View  
Slot Orientation  
1/8 DIN Horizontal PM9**

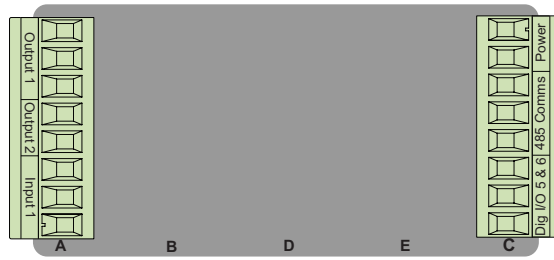

**Back View  
Slot Orientation  
1/4 DIN Horizontal PM4**

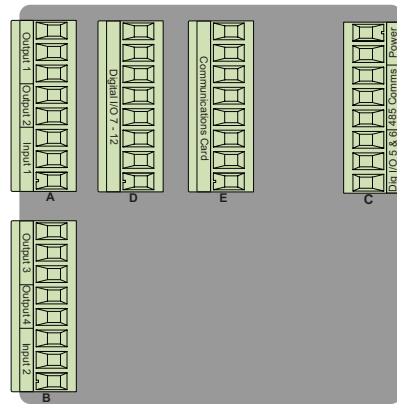

**EZ-ZONE PM Isolation Blocks**

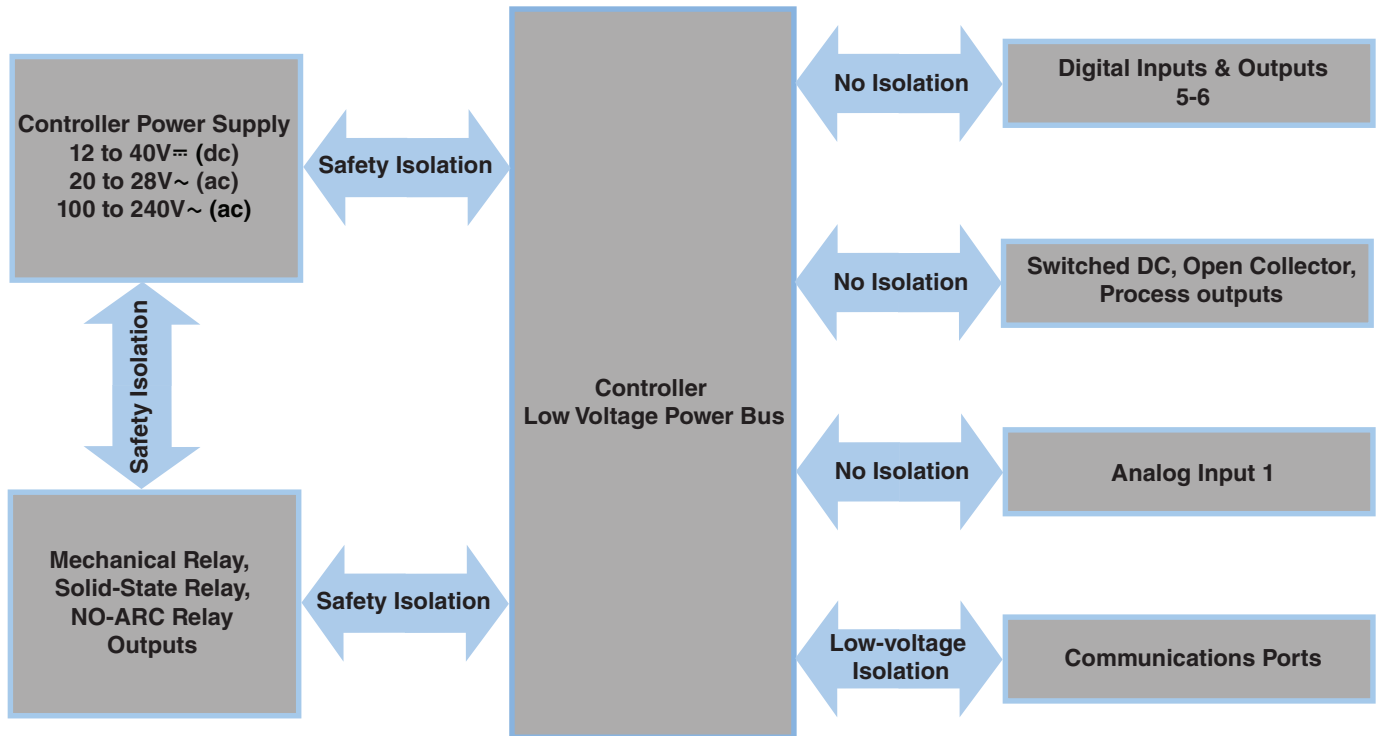

Low-voltage Isolation: 42V peak  
Safety Isolation: 2300V~ (ac)



**Warning:**  
Use National Electric (NEC) or other country-specific standard wiring and safety practices when wiring and connecting this controller to a power source and to electrical sensors or peripheral devices. Failure to do so may result in damage to equipment and property, and/or injury or loss of life.

**Note:**  
Maximum wire size termination and torque rating:  

- 0.0507 to 3.30 mm<sup>2</sup> (30 to 12 AWG) single-wire termination or two 1.31 mm<sup>2</sup> (16 AWG)
- 0.8 Nm (7.0 lb.-in.) torque

**Note:**  
Adjacent terminals may be labeled differently, depending on the model number.

**Note:**  
To prevent damage to the controller, do not connect wires to unused terminals.

**Note:**  
Maintain electrical isolation between analog input 1, digital input-outputs, switched dc/open collector outputs and process outputs to prevent ground loops.

**Note:**  
The control output common terminal and the digital common terminal are referenced to different voltages and must remain isolated.

## Low Power

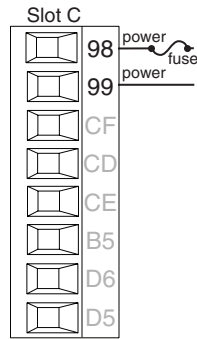

- Minimum/Maximum Ratings
  - 12 to 40V $\approx$  (dc)
  - 20 to 28V $\sim$  (ac) Semi Sig F47
  - 47 to 63 Hz
  - 14VA maximum power consumption (PM4,8 & 9)
  - 10VA maximum power consumption (PM3 & 6)
- PM\_\_ [3,4] \_ \_ - - - - -

## High Power

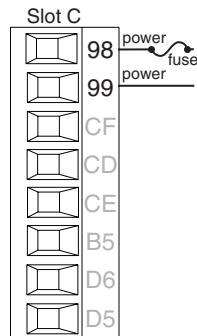

- Minimum/Maximum Ratings
  - 85 to 264V $\sim$  (ac)
  - 100 to 240V $\sim$  (ac) Semi Sig F47
  - 47 to 63 Hz
  - 14VA maximum power consumption (PM4,8 & 9)
  - 10VA maximum power consumption (PM3 & 6)
- PM\_\_ [1,2] \_ \_ - - - - -

## Digital Input 5, 6

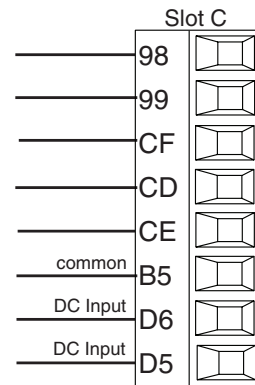

- Digital Input**
- Update rate 10 Hz
  - Dry contact or dc voltage

- DC Voltage**
- Input not to exceed 36V at 3 mA
  - Input active when > 3V @ 0.25 mA
  - Input inactive when < 2V

- Dry Contact**
- Input inactive when > 500  $\Omega$
  - Input active when < 100  $\Omega$
  - maximum short circuit 13 mA
- PM\_\_ [2,4] \_ \_ - - - - -

### Voltage Input

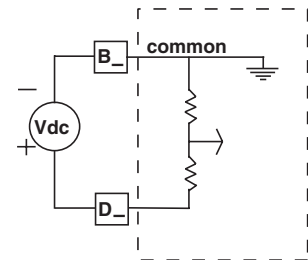

### Dry Contact

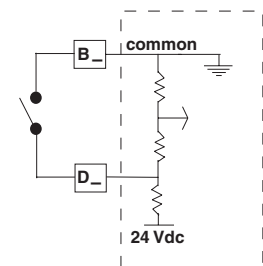



**Warning:**  
 Use National Electric (NEC) or other country-specific standard wiring and safety practices when wiring and connecting this controller to a power source and to electrical sensors or peripheral devices. Failure to do so may result in damage to equipment and property, and/or injury or loss of life.

**Note:**  
 Maximum wire size termination and torque rating:  
 • 0.0507 to 3.30 mm<sup>2</sup> (30 to 12 AWG) single-wire termination or two 1.31 mm<sup>2</sup> (16 AWG)  
 • 0.8 Nm (7.0 lb.-in.) torque

**Note:**  
 Adjacent terminals may be labeled differently, depending on the model number.

**Note:**  
 To prevent damage to the controller, do not connect wires to unused terminals.

**Note:**  
 Maintain electrical isolation between analog input 1, digital input-outputs, switched dc/open collector outputs and process outputs to prevent ground loops.

**Note:**  
 The control output common terminal and the digital common terminal are referenced to different voltages and must remain isolated.

## Input 1 Thermocouple

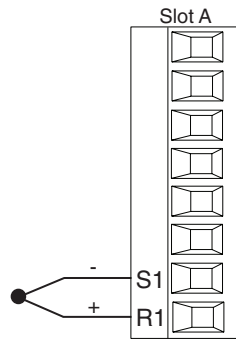

- 2 k $\Omega$  maximum source resistance
- >20 M $\Omega$  input impedance
- 3 microampere open-sensor detection
- Thermocouples are polarity sensitive. The negative lead (usually red) must be connected to S1.
- To reduce errors, the extension wire for thermocouples must be of the same alloy as the thermocouple.

PM \_ \_ \_ \_ \_ AAAA \_ \_

## Input 1 RTD

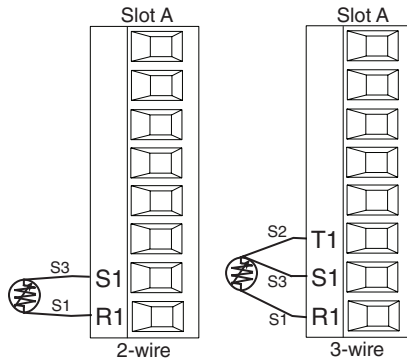

- platinum, 100 and 1,000  $\Omega$  @ 0°C
- calibration to DIN curve (0.00385  $\Omega/\Omega/^\circ\text{C}$ )
- 20  $\Omega$  total lead resistance
- RTD excitation current of 0.09 mA typical. Each ohm of lead resistance may affect the reading by 0.03°C.
- For 3-wire RTDs, the S1 lead (usually white) must be connected to R1.
- For best accuracy use a 3-wire RTD to compensate for lead-length resistance. All three lead wires must have the same resistance.

PM \_ \_ \_ \_ \_ AAAA \_ \_

## Input 1 Process

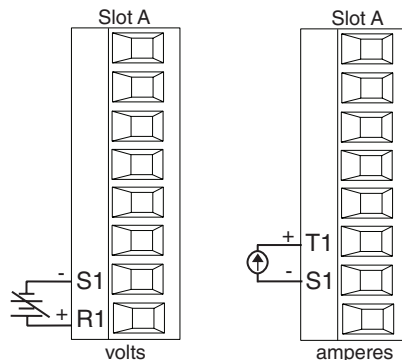

- 0 to 20 mA @ 100  $\Omega$  input impedance
- 0 to 10V $\overline{=}$  (dc) @ 20 k $\Omega$  input impedance
- 0 to 50 mV $\overline{=}$  (dc) @ 20 k $\Omega$  input impedance
- scalable

PM \_ \_ \_ \_ \_ AAAA \_ \_

## Input 1 Potentiometer

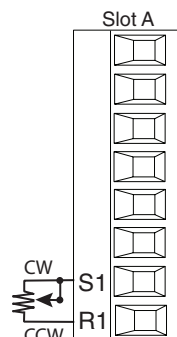

- Use a 1 k $\Omega$  potentiometer.

PM \_ \_ \_ \_ \_ AAAA \_ \_



**Warning:**  
Use National Electric (NEC) or other country-specific standard wiring and safety practices when wiring and connecting this controller to a power source and to electrical sensors or peripheral devices. Failure to do so may result in damage to equipment and property, and/or injury or loss of life.

**Note:**  
Maximum wire size termination and torque rating:  
• 0.0507 to 3.30 mm<sup>2</sup> (30 to 12 AWG) single-wire termination or two 1.31 mm<sup>2</sup> (16 AWG)  
• 0.8 Nm (7.0 lb.-in.) torque

**Note:**  
Adjacent terminals may be labeled differently, depending on the model number.

**Note:**  
To prevent damage to the controller, do not connect wires to unused terminals.

**Note:**  
Maintain electrical isolation between analog input 1, digital input-outputs, switched dc/open collector outputs and process outputs to prevent ground loops.

**Note:**  
The control output common terminal and the digital common terminal are referenced to different voltages and must remain isolated.

## Input 1 Thermistor

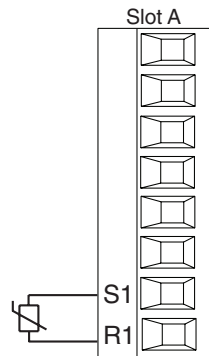

- >20 M $\Omega$  input impedance
  - 3 microampere open-sensor detection
- Input 1: PM \_ [J,N,E\*] \_ \_ \_ \_ \_ (S1/R1)

\*PM4,8 & 9 only



**Warning:**  
Use National Electric (NEC) or other country-specific standard wiring and safety practices when wiring and connecting this controller to a power source and to electrical sensors or peripheral devices. Failure to do so may result in damage to equipment and property, and/or injury or loss of life.

**Note:**  
Maximum wire size termination and torque rating:  
• 0.0507 to 3.30 mm<sup>2</sup> (30 to 12 AWG) single-wire termination or two 1.31 mm<sup>2</sup> (16 AWG)  
• 0.8 Nm (7.0 lb.-in.) torque

**Note:**  
Adjacent terminals may be labeled differently, depending on the model number.

**Note:**  
To prevent damage to the controller, do not connect wires to unused terminals.

**Note:**  
Maintain electrical isolation between analog input 1, digital input-outputs, switched dc/open collector outputs and process outputs to prevent ground loops.

**Note:**  
The control output common terminal and the digital common terminal are referenced to different voltages and must remain isolated.

**Quencharc Note:**  
Switching pilot duty inductive loads (relay coils, solenoids, etc.) with the mechanical relay, solid state relay or open collector output options requires use of an R.C. suppressor.

## Digital Output 5, 6

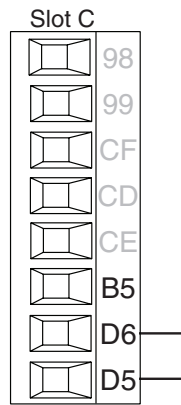

### Digital Output

- Update rate 10 Hz
  - Output voltage 24V
  - Current limit, Output 5, 24 mA maximum
  - Current limit, Output 6, 10 mA maximum driving single pole DIN-A-MITE
  - Capable of driving a 3-pole DIN-A-MITE
  - Open-circuit voltage 22 to 32V<sub>DC</sub> (dc)
- PM \_ \_ [2,4] \_ \_ \_ \_ \_

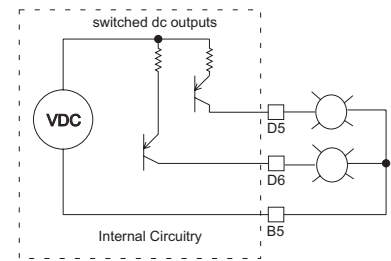

## Switched DC Wiring Example Using DO 5 and 6

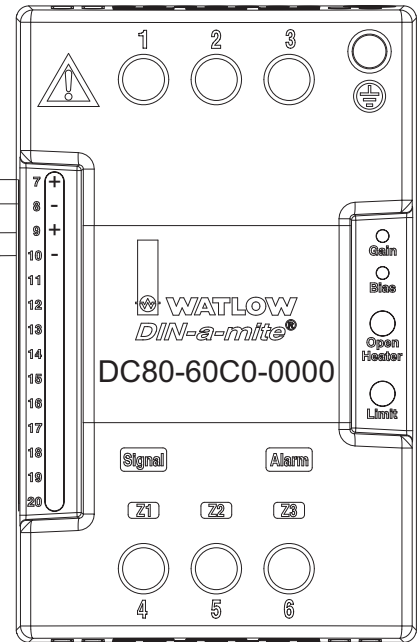
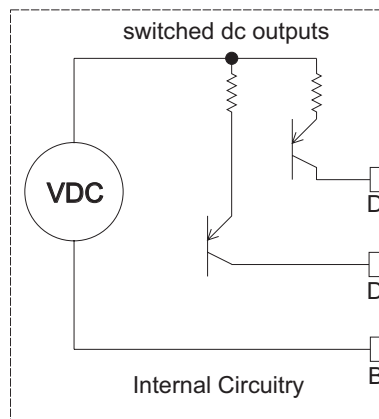



**Warning:**

Use National Electric (NEC) or other country-specific standard wiring and safety practices when wiring and connecting this controller to a power source and to electrical sensors or peripheral devices. Failure to do so may result in damage to equipment and property, and/or injury or loss of life.

**Note:**

Maximum wire size termination and torque rating:

- 0.0507 to 3.30 mm<sup>2</sup> (30 to 12 AWG) single-wire termination or two 1.31 mm<sup>2</sup> (16 AWG)
- 0.8 Nm (7.0 lb.-in.) torque

**Note:**

Adjacent terminals may be labeled differently, depending on the model number.

**Note:**

To prevent damage to the controller, do not connect wires to unused terminals.

**Note:**

Maintain electrical isolation between analog input 1, digital input-outputs, switched dc/open collector outputs and process outputs to prevent ground loops.

**Note:**

The control output common terminal and the digital common terminal are referenced to different voltages and must remain isolated.

**Quencharc Note:**

Switching pilot duty inductive loads (relay coils, solenoids, etc.) with the mechanical relay, solid state relay or open collector output options requires use of an R.C. suppressor.

## Output 1 Switched DC/Open Collector

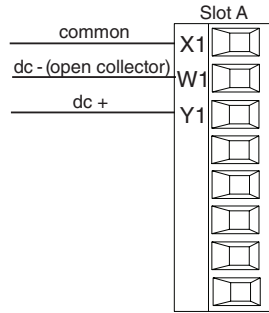

### Switched DC

- 30 mA dc maximum supply current
- short circuit limited to <50 mA
- 22 to 32V $\approx$  (dc) open circuit voltage
- Use dc- and dc+ to drive external solid-state relay.
- DIN-A-MITE compatible
- single-pole: up to 4 in parallel or 4 in series
- 2-pole: up to 2 in parallel or 2 in series
- 3-pole: up to 2 in series

### Open Collector

- 100 mA maximum output current sink
- 30V $\approx$  (dc) maximum supply voltage
- Any switched dc output can use the common terminal.
- Use an external power supply to control a dc load, with the load positive to the positive of the power supply, the load negative to the open collector and common to the power supply negative.

See Quencharc note.

PM \_ \_ \_ [C] \_ - AAAA \_ \_

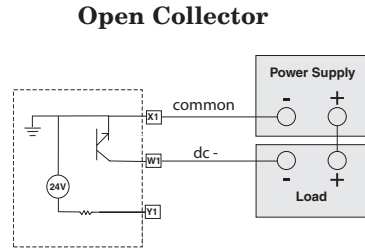
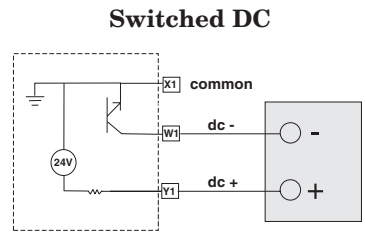

## Output 1 Mechanical Relay, Form C

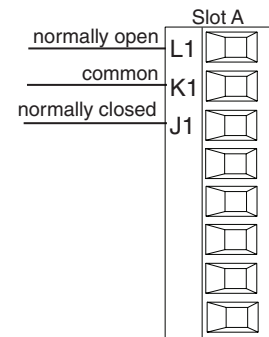

- 5 A at 240V $\sim$  (ac) or 30V $\approx$  (dc) maximum resistive load
- 20 mA at 24V minimum load
- 125 VA pilot duty at 120/240V $\sim$  (ac), 25 VA at 24V $\sim$  (ac)
- 100,000 cycles at rated load
- Output does not supply power.
- for use with ac or dc

See Quencharc note.

PM \_ \_ \_ [E] \_ - AAAA \_ \_

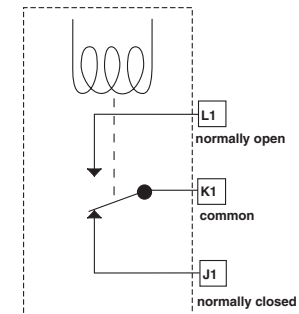

## Output 1 Universal Process

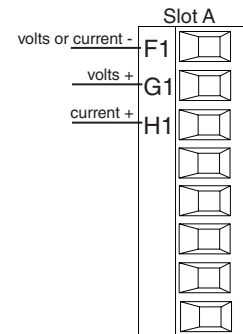

- 0 to 20 mA into 800  $\Omega$  maximum load
- 0 to 10V $\approx$  (dc) into voltage 1 k $\Omega$  minimum load
- scalable
- output supplies power
- cannot use voltage and current outputs at same time
- Output may be used as re-transmit or control.

PM \_ \_ \_ [F] \_ - AAAA \_ \_

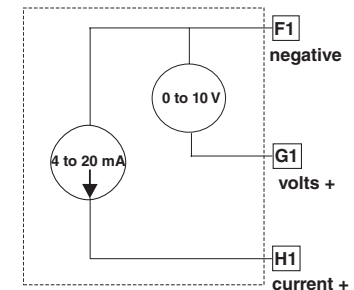



**Warning:**

Use National Electric (NEC) or other country-specific standard wiring and safety practices when wiring and connecting this controller to a power source and to electrical sensors or peripheral devices. Failure to do so may result in damage to equipment and property, and/or injury or loss of life.

**Note:**

Maximum wire size termination and torque rating:

- 0.0507 to 3.30 mm<sup>2</sup> (30 to 12 AWG) single-wire termination or two 1.31 mm<sup>2</sup> (16 AWG)
- 0.8 Nm (7.0 lb.-in.) torque

**Note:**

Adjacent terminals may be labeled differently, depending on the model number.

**Note:**

To prevent damage to the controller, do not connect wires to unused terminals.

**Note:**

Maintain electrical isolation between analog input 1, digital input-outputs, switched dc/open collector outputs and process outputs to prevent ground loops.

**Note:**

The control output common terminal and the digital common terminal are referenced to different voltages and must remain isolated.

**Quencharc Note:**

Switching pilot duty inductive loads (relay coils, solenoids, etc.) with the mechanical relay, solid state relay or open collector output options requires use of an R.C. suppressor.

## Output 1 Solid-State Relay, Form A

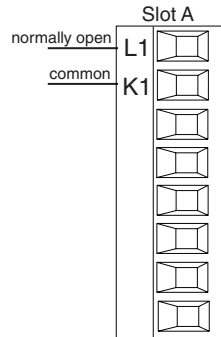

- 0.5 A at 20 to 264V~ (ac) maximum resistive load
- 20 VA 120/240V~ (ac) pilot duty
- opto-isolated, without contact suppression
- maximum off state leakage of 105 microamperes
- output does not supply power
- Do not use on dc loads.
- See Quencharc note.

PM \_ \_ \_ [K] \_ \_ AAAA \_ \_

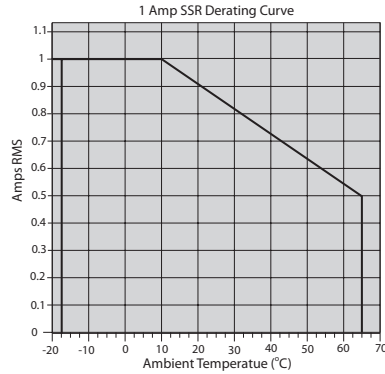
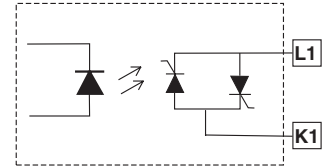

## Output 2 Switched DC

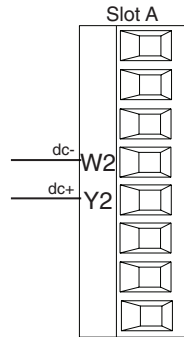

- 10 mA dc maximum supply current
- short circuit limited to <50 mA
- 22 to 32V= (dc) open circuit voltage
- use dc- and dc+ to drive external solid-state relay
- DIN-A-MITE compatible
- single-pole: up to 2 in series, none in parallel

PM \_ \_ \_ [C] \_ \_ AAAA \_ \_

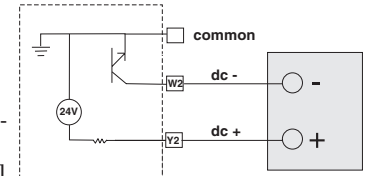





**Warning:**  
 Use National Electric (NEC) or other country-specific standard wiring and safety practices when wiring and connecting this controller to a power source and to electrical sensors or peripheral devices. Failure to do so may result in damage to equipment and property, and/or injury or loss of life.

**Note:**  
 Maximum wire size termination and torque rating:  
 • 0.0507 to 3.30 mm<sup>2</sup> (30 to 12 AWG) single-wire termination or two 1.31 mm<sup>2</sup> (16 AWG)  
 • 0.8 Nm (7.0 lb.-in.) torque

**Note:**  
 Adjacent terminals may be labeled differently, depending on the model number.

**Note:**  
 To prevent damage to the controller, do not connect wires to unused terminals.

**Note:**  
 Maintain electrical isolation between analog input 1, digital input-outputs, switched dc/open collector outputs and process outputs to prevent ground loops.

**Note:**  
 The control output common terminal and the digital common terminal are referenced to different voltages and must remain isolated.

## Output 2 NO-ARC Relay, Form A

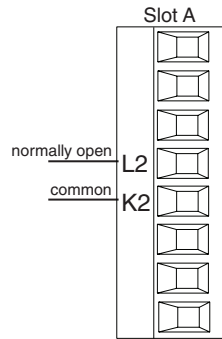

- 15 A at 85 to 264V~ (ac) resistive load only
  - 1/16 DIN models only
  - 2,000,000 cycle rating for NO-ARC circuit
  - 100 mA minimum load
  - 2 mA maximum off state leakage
  - Do not use on dc loads.
  - Output does not supply power.
- PM [4, 6, 8, 9] \_ \_ \_ [H]\_ AAAAA  
 \_ \_

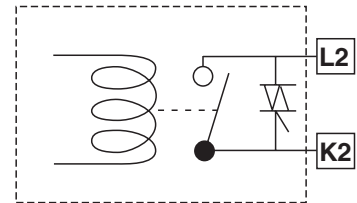

## Output 2 Mechanical Relay, Form A

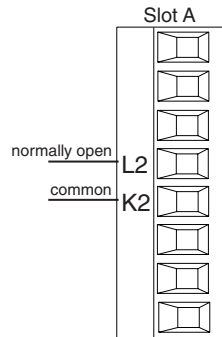

- 5 A at 240V~ (ac) or 30V= (dc) maximum resistive load
  - 20 mA at 24V minimum load
  - 125 VA pilot duty @ 120/240V~ (ac), 25 VA at 24V~ (ac)
  - 100,000 cycles at rated load
  - Output does not supply power.
  - for use with ac or dc
- See Quencharc note.  
 PM \_ \_ \_ \_ [J]\_ AAAAA \_ \_

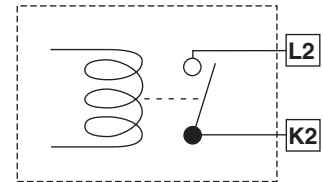

## Output 2 Solid-state Relay, Form A

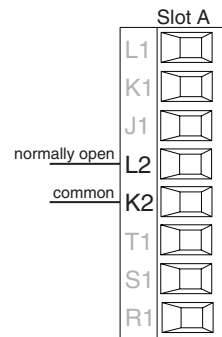

- 0.5 A at 20 to 264V~ (ac) maximum resistive load
  - 20 VA 120/240V~ (ac) pilot duty
  - opto-isolated, without contact suppression
  - maximum off state leakage of 105 microamperes
  - Output does not supply power.
  - Do not use on dc loads.
- See Quencharc note.  
 PM \_ \_ \_ \_ [K]\_ AAAAA \_ \_

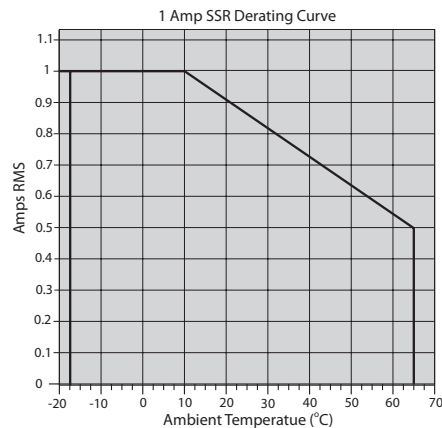
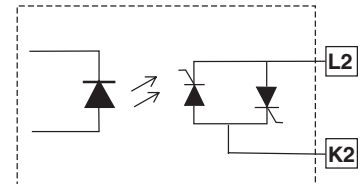



**Warning:**  
Use National Electric (NEC) or other country-specific standard wiring and safety practices when wiring and connecting this controller to a power source and to electrical sensors or peripheral devices. Failure to do so may result in damage to equipment and property, and/or injury or loss of life.

**Note:**  
Maximum wire size termination and torque rating:  
 • 0.0507 to 3.30 mm<sup>2</sup> (30 to 12 AWG) single-wire termination or two 1.31 mm<sup>2</sup> (16 AWG)  
 • 0.8 Nm (7.0 lb.-in.) torque

**Note:**  
Adjacent terminals may be labeled differently, depending on the model number.

**Note:**  
To prevent damage to the controller, do not connect wires to unused terminals.

**Note:**  
Maintain electrical isolation between analog input 1, digital input-outputs, switched dc/open collector outputs and process outputs to prevent ground loops.

**Note:**  
The control output common terminal and the digital common terminal are referenced to different voltages and must remain isolated.

**Note:**  
Avoid continuous writes within loops. Excessive writes to EEPROM will cause premature EEPROM failure. The EEPROM is rated for 1,000,000 writes.

## Quencharc Wiring Example

In this example the Quencharc circuit (Watlow part# 0804-0147-0000) is used to protect PM internal circuitry from the counter electro-magnetic force from the inductive user load when de-energized. It is recommended that this or an equivalent Quencharc be used when connecting inductive loads to PM outputs.

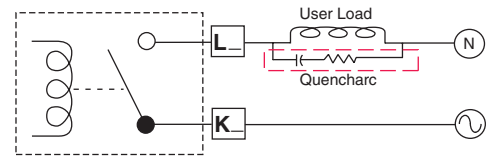

## Standard Bus EIA-485 Communications

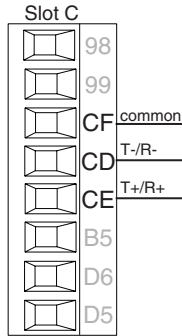

- Wire T-/R- to the A terminal of the EIA-485 port.
- Wire T+/R+ to the B terminal of the EIA-485 port.
- Wire common to the common terminal of the EIA-485 port.
- Do not route network wires with power wires. Connect network wires in daisy-chain fashion when connecting multiple devices in a network.
- Do not connect more than 16 EZ-ZONE PM controllers on a network.
- maximum network length: 1,200 meters (4,000 feet)
- 1/8th unit load on EIA-485 bus  
PM \_ \_ \_ \_ \_-[A] AAAA \_ \_

## Modbus RTU or Standard Bus EIA-485 Communications

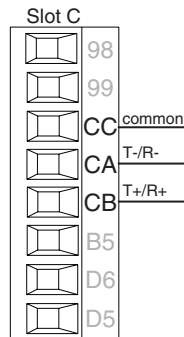

- Wire T-/R- to the A terminal of the EIA-485 port.
- Wire T+/R+ to the B terminal of the EIA-485 port.
- Wire common to the common terminal of the EIA-485 port.
- Do not route network wires with power wires. Connect network wires in daisy-chain fashion when connecting multiple devices in a network.
- A termination resistor may be required. Place a 120 Ω resistor across T+/R+ and T-/R- of last controller on network.
- Only one protocol per port is available at a time: either Modbus RTU or Standard Bus.
- Do not connect more than 16 EZ-ZONE PM controllers on a Standard Bus network.
- Do not connect more than 247 EZ-ZONE PM controllers on a Modbus RTU network.
- maximum network length: 1,200 meters (4,000 feet)
- 1/8th unit load on EIA-485 bus.  
PM \_ \_ \_ \_ \_-[1] AAAA \_ \_

Modbus-IDA Terminal	EIA/TIA-485 Name	Watlow Terminal Label	Function
DO	A	CA or CD	T-/R-
D1	B	CB or CE	T+/R+
common	common	CC or CF	common

## Wiring a Serial EIA-485 Network

Two example networks are shown below where the first one is using Watlow's Standard Bus and the other showing connections over Modbus. Do not route network wires with power wires. Connect network wires in daisy-chain fashion when connecting multiple devices in a network. A termination resistor may be required. Place a 120 Ω resistor across T+/R+ and T-/R- of the last controller on a network. Only one protocol per port is available at a time: either Modbus RTU or Standard Bus.



**Warning:**  
Use National Electric (NEC) or other country-specific standard wiring and safety practices when wiring and connecting this controller to a power source and to electrical sensors or peripheral devices. Failure to do so may result in damage to equipment and property, and/or injury or loss of life.

**Note:**  
Maximum wire size termination and torque rating:  
• 0.0507 to 3.30 mm<sup>2</sup> (30 to 12 AWG) single-wire termination or two 1.31 mm<sup>2</sup> (16 AWG)  
• 0.8 Nm (7.0 lb.-in.) torque

**Note:**  
Adjacent terminals may be labeled differently, depending on the model number.

**Note:**  
To prevent damage to the controller, do not connect wires to unused terminals.

**Note:**  
Maintain electrical isolation between analog input 1, digital input-outputs, switched dc/open collector outputs and process outputs to prevent ground loops.

**Note:**  
The control output common terminal and the digital common terminal are referenced to different voltages and must remain isolated.

### A Network Using Watlow's Standard Bus and an RUI/Gateway

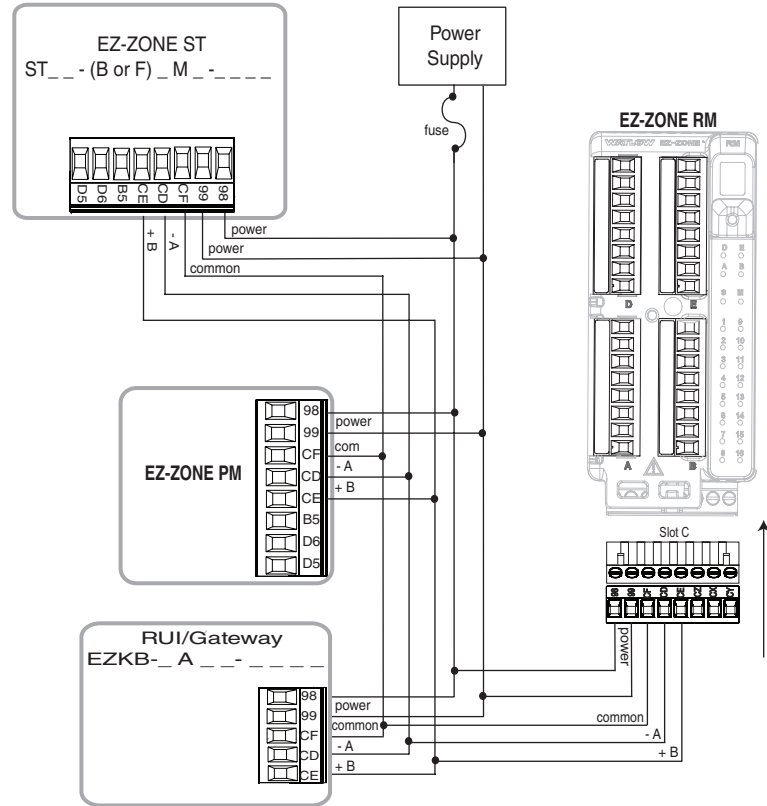

### A Network Using Modbus RTU.

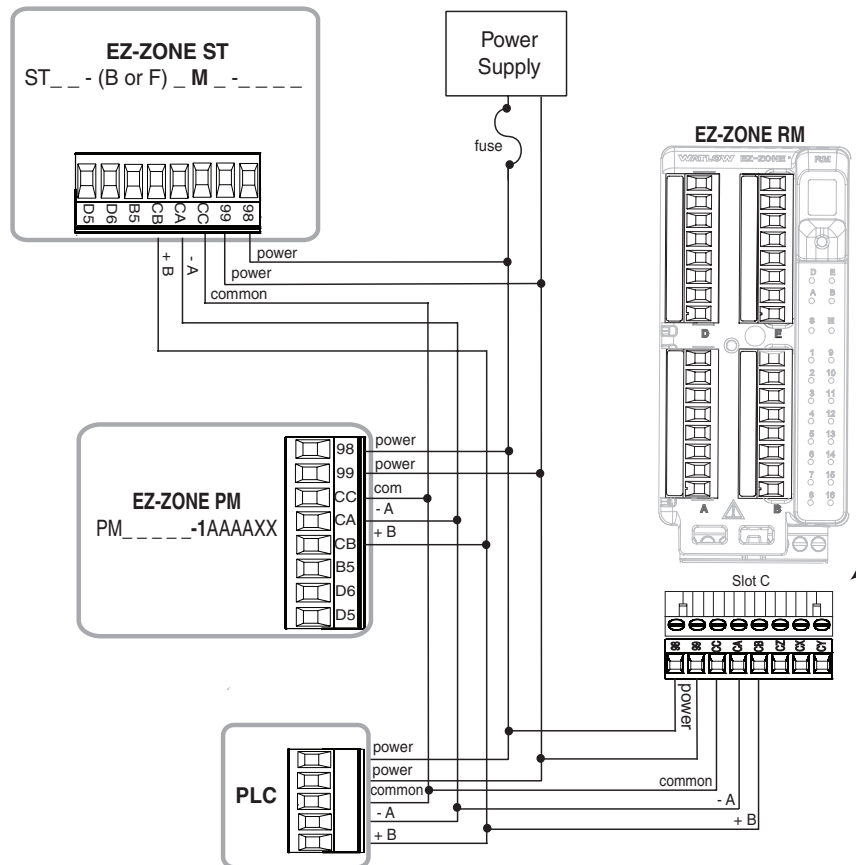



**Warning:**  
Use National Electric (NEC) or other country-specific standard wiring and safety practices when wiring and connecting this controller to a power source and to electrical sensors or peripheral devices. Failure to do so may result in damage to equipment and property, and/or injury or loss of life.

**Note:**  
Maximum wire size termination and torque rating:  
• 0.0507 to 3.30 mm<sup>2</sup> (30 to 12 AWG) single-wire termination or two 1.31 mm<sup>2</sup> (16 AWG)  
• 0.8 Nm (7.0 lb.-in.) torque

**Note:**  
Adjacent terminals may be labeled differently, depending on the model number.

**Note:**  
To prevent damage to the controller, do not connect wires to unused terminals.

**Note:**  
Maintain electrical isolation between analog input 1, digital input-outputs, switched dc/open collector outputs and process outputs to prevent ground loops.

**Note:**  
The control output common terminal and the digital common terminal are referenced to different voltages and must remain isolated.

## Connecting a Computer to PM Controls Using B&B 485 to USB Converter

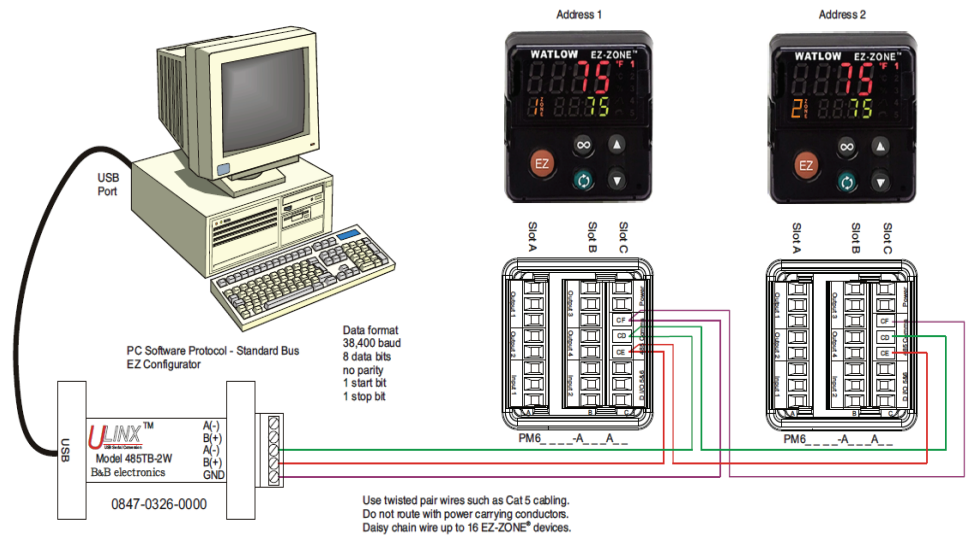

# 3

## Chapter 3: Keys and Displays

### Upper (Left, 32<sup>nd</sup> DIN) Display:

In the Home Page, displays the process value, otherwise displays the value of the parameter in the lower display.

### Zone Display:

Indicates the controller zone.

1 to 9 = zones 1 to 9

A = zone 10      E = zone 14  
 b = zone 11      F = zone 15  
 C = zone 12      h = zone 16  
 d = zone 13

### Percent Units:

Lights when the controller is displaying values as a percentage or when the open-loop set point is displayed.

### Channel Display:

Indicates the channel for any given EZ-ZONE module.

- Available with the PM4, 8 and PM9 only.

### Infinity Key ∞

Press to back up one level, or press and hold for two seconds to return to the Home Page. From the Home Page can clear alarms and errors if clearable.

### Advance Key ↻

Advances through parameter prompts.

### 1/32 DIN (PM3)

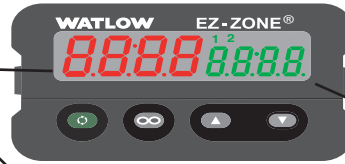

### Lower (Right, 32<sup>nd</sup> DIN) Display:

Indicates the set point or output power value during operation, or the parameter whose value appears in the upper display.

### 1/16 DIN (PM6)

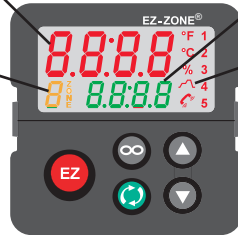

### Profile Activity:

Lights when a profile is running. Flashes when a profile is paused.

### EZ Key/s:

This key can be programmed to do various tasks, such as locking the keyboard, restoring user settings, etc...

### 1/8 DIN (PM9) Horizontal

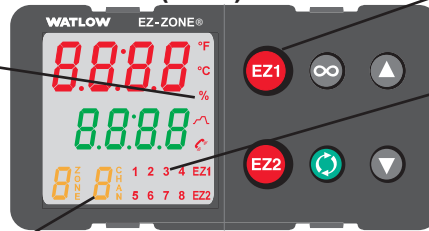

### Output Activity:

Number LEDs indicate activity of outputs. A flashing light indicates output activity.

### 1/8 DIN (PM8) Vertical



### Communications Activity

Flashes when another device is communicating with this controller.

### Temperature Units:

Indicates whether the temperature is displayed in Fahrenheit or Celsius.

### Up and Down Keys ▲ ▼

In the Home Page, adjusts the set point in the lower display. In other pages, changes the upper display to a higher or lower value, or changes a parameter selection.

### 1/4 DIN (PM4)

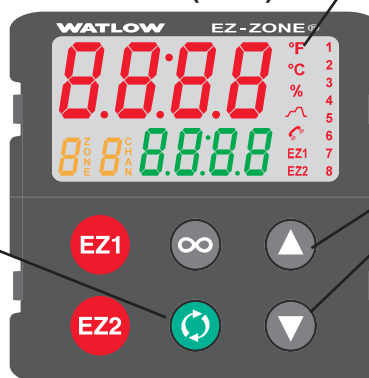

## Responding to a Displayed Message

An active message will cause the display to toggle between the normal settings and the active message in the upper display and **Attn** in the lower display.

Your response will depend on the message and the controller settings. Some messages, such as Ramping and Tuning, indicate that a process is underway. If the message was generated by a latched alarm and the condition no longer exists or if an alarm has si-

lencing enabled it can be silenced simply by pushing the Infinity **∞** key. Alternatively, use the method below to view all and then clear.

Push the Advance Key to display **gnc** in the upper display and the message source (such as **ALh1**) in the lower display. Use the Up **▲** or Down **▼** keys to scroll through possible responses, such as Clear **CLR** or Silence **SIL**. Then push the Advance **⏩** or Infinity **∞** key to execute the action. See the Home Page for further information on the Attention Codes.

Display	Parameter Name Description	Range	Appears If
<b>Attn</b>	<p><b>Attention</b></p> <p>An active message will cause the display to toggle between the normal settings and the active message in the upper display and <b>Attn</b> in the lower display.</p> <p>Your response will depend on the message and the controller settings. Some messages, such as Ramping and Tuning, indicate that a process is underway. If the message was generated by a latched alarm or limit condition, the message can be cleared when the condition no longer exists. If an alarm has silencing enabled, it can be silenced.</p> <p>Push the Advance Key to display <b>gnc</b> in the upper display and the message source (such as <b>ALh1</b>) in the lower display.</p> <p>Use the Up <b>▲</b> or Down <b>▼</b> keys to scroll through possible responses, such as Clear <b>CLR</b> or Silence <b>SIL</b>. Then push the Advance <b>⏩</b> or Infinity <b>∞</b> key to execute the action. Alternatively, rather than scrolling through all messages simply push the Infinity <b>∞</b> button to generate a clear.</p>	<p><b>ALL1 ALL2 ALL3</b>  <b>ALL4</b> Alarm Low 1 to 4</p> <p><b>ALh1 ALh2 ALh3</b>  <b>ALh4</b> Alarm High 1 to 4</p> <p><b>ALE1 ALE2 ALE3</b>  <b>ALE4</b> Alarm Error 1 to 4</p> <p><b>Er.1</b> Error Input 1</p> <p><b>TUn1</b> Tuning 1</p> <p><b>rP1</b> Ramping 1</p> <p><b>LPo1</b> Loop Open Error 1</p> <p><b>LP.r1</b> Loop Reversed Error 1</p>	an alarm or error message is active.

# 4

## Chapter 4: Home Page

### Default Home Page Parameters

Watlow's patented user-defined menu system improves operational efficiency. The user-defined Home Page provides you with a shortcut to monitor or change the parameter values that you use most often. The default Home Page is shown on the following page. When a parameter normally located in the Setup Page or Operations Page is placed in the Home Page, it is accessible through both. If you change a parameter in the Home Page, it is automatically changed in its original page. If you change a parameter in its original page it is automatically changed in the Home Page.

The Attention **ATTN** parameter appears only if there is an active message. An example of an active message could be an Input Error **ERRI**, or it could be for information only like Autotune **ETUN** taking place.

Use the Advance Key **⏩** to step through the other parameters. When not in pairs the parameter prompt will appear in the lower display, and the parameter value will appear in the upper display. You can use the Up **⬆** and Down **⬇** keys to change the value of writable parameters, just as you would in any other menu.

If Control Mode is set to Auto, the Process Value is in the upper display and the Closed Loop Set Point (read-write) is in the lower display.

If a profile is running, the process value is in the upper display and the Target Set Point (read only) is in the lower display. If Control Mode is set to Manual, the Process Value is in the upper display and the output power level (read-write) is in the lower display.

If Control Mode is set to Off, the Process Value is in the upper display and **OFF** (read only) is in the lower display.

If a sensor failure has occurred, **----** is in the upper display and the output power level (read-write) is in the lower display.

### Changing the Set Point

You can change the set point by using the Up **⬆** or Down **⬇** keys when a profile is not running.

### Modifying the Home Page

To modify the Home Page proceed to the Factory Menu by pushing and holding the Advance **⏩** key and the Infinity **∞** key for approximately six seconds. Upon entering the Factory Page the first menu will be the Custom Menu **CMSE**. Once there push the Advance **⏩** key where the lower display will show **CMSE** and the upper display will show **1**. Again, push the Advance **⏩** button where the prompt for the

Active Process Value **RLPV** will be displayed on top and Parameter **PRR** in the bottom. Using the Up **⬆** or Down **⬇** arrow keys will allow for a customized selection of choice. There are twenty positions available that can be customized.

### Modifying the Display Pairs

The Home Page, being a customized list of as many as 20 parameters can be configured in pairs of up to 10 via the Display Pairs **dPrS** prompt found in the Diagnostic Menu **dRG** (Factory Page). The listing in the table that follows is what one may typically find in the Home Page as defaults based on controller part numbers. It is important to note that some of the prompts shown may not appear simply because the feature is not being used or is turned off. As an example, the prompt Cool Power **CPRI** will not appear unless the Cool algorithm **CRG** is turned on in the Setup Page under the Loop menu. The Display Pairs **dPrS** prompt will default to 1, therefore the upper display will reflect the Active Process Value **RLPV** and the lower display will reflect the Active Set Point **RLSP** by default.

As stated above, the user can define pairs of prompts to appear on the display every time the Advance **⏩** key is pushed. When configuring the Custom Menu to your liking it should be noted that if 2 changeable (writable) prompts are displayed in a Pair, i.e., Control Mode on top and Idle Set Point on the bottom, only the lower display (Idle Set Point) can be changed.

The display can be configured to scroll by going to the Factory Page under the Diagnostic Menu and changing the Display Time **dTI** prompt to something greater than 0. If set to 2, the display will scroll every 2 seconds from one Display Pair to another. If the Display Pair prompt **dPrS** is set to 1 the Display Time **dTI** prompt will have no effect on the display.

	Home Page Defaults	Home Page Display	Parameter Page and Menu
<b>All Models</b>			
1	Active Process Value (1)	Numerical value	Operations Page, Monitor Menu
2	Active Set Point (1)	Numerical value	Operations Page, Monitor Menu
3	User Control Mode (1)	<b>[C,P7 I]</b>	Operations Page, Monitor Menu
4	Heat Power (1)	<b>[h,P r I]</b>	Operations Page, Monitor Menu
5	Cool Power (1)	<b>[C,P r I]</b>	Operations Page, Monitor Menu
6	Autotune (1)	<b>[R u t I]</b>	Operations Page, Loop Menu
7	Idle (1)	<b>[,id5 I]</b>	Operations Page, Loop Menu
8	* Start Profile	<b>[P,St I]</b>	
9	* Action Request	<b>[P,RC I]</b>	
10	None		
11	None		
12	None		
13	None		
14	None		
15	None		
16	None		
17	None		
18	None		
19	None		
20	None		

\* The fourth digit of the part number must be:  
 PM \_ [**R, B, N or E**] \_ \_ \_ - \_ \_ \_ \_ \_



# Navigating the EZ-ZONE® PM PID Controller

Applies to All Models - 1/16 DIN Shown Below

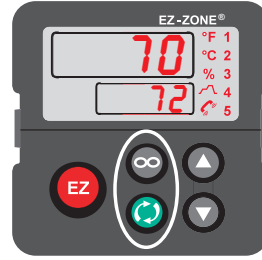

**Home Page from anywhere:** Press the Infinity Key ∞ for two seconds to return to the Home Page.

**Factory Page from Home Page:** Press both the Advance ⌚ and Infinity ∞ keys for six seconds.



**Operations Page from Home Page:** Press both the Up ▲ and Down ▼ keys for three seconds.

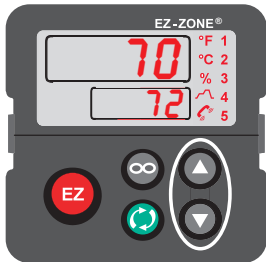

**Setup Page from Home Page:** Press both the Up ▲ and Down ▼ keys for six seconds.

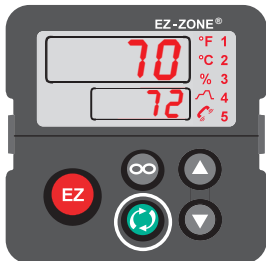

**Profiling Page from Home Page:** Press the Advance Key ⌚ for three seconds.

## Conventions Used in the Menu Pages

To better understand the menu pages that follow review the naming conventions used. When encountered throughout this document, the word "default" implies as shipped from the factory. Each page (Operations, Setup, Profile and Factory) and their associated menus have identical headers defined below:

Header Name	Definition
Display	Visually displayed information from the control.
Parameter Name	Describes the function of the given parameter.
Range	Defines options available for this prompt, i.e., min/max values (numerical), yes/no, etc... (further explanation below).
Default	Values as delivered from the factory.
Modbus Relative Address	Identifies unique parameters using either the Modbus RTU or Modbus TCP protocols (further explanation below).
CIP (Common Industrial Protocol)	Identifies unique parameters using either the DeviceNet or EtherNet/IP protocol (further explanation below).
Profibus Index	Identifies unique parameters using Profibus DP protocol (further explanation below).
Parameter ID	Identifies unique parameters used with other software such as, LabVIEW.
Data Type R/W	uint = Unsigned 16 bit integer dint = long, 32-bit string = ASCII (8 bits per character) float = IEEE 754 32-bit RWES = <b>R</b> eadable <b>W</b> ritable <b>E</b> EPROM (saved) <b>S</b> et (saved)

## Display

Visual information from the control is displayed to the observer using a fairly standard 7 segment display. Due to the use of this technology, several characters displayed need some interpretation, see the list below:

= 1	= 0	= i	= r
= 2	= A	= J	= S
= 3	= b	= K	= t
= 4	= c	= L	= u
= 5	= d	= M	= v
= 6	= E	= n	= W
= 7	= F	= o	= y
= 8	= g	= P	= Z
= 9	= h	= q	

## Range

Within this column notice that on occasion there will be numbers found within parenthesis. This number represents the enumerated value for that particular selection. Range selections can be made simply by writing the enumerated value of choice using any of the available communications protocols. As an example, turn to the Setup Page and look at the Analog Input menu and then the Sensor Type prompt. To turn the sensor off simply write the value of 62 (off) to Modbus register 400369 and send that value to the control.

## Modbus RTU Protocols

All Modbus registers are 16-bits and as displayed in this manual are relative addresses (actual). Some legacy software packages limit available Modbus registers to 40001 to 49999 (5 digits). Many applications today require access to all available Modbus registers which range from 400001 to 465535 (6 digits). Watlow controls support 6 digit Modbus registers. For parameters listed as float notice that only one (low order) of the two registers is listed, this is true throughout this document. By default the low order word contains the two low bytes of the 32-bit parameter. As an example, look in the Operations Page for the Process Value. Find the column identified in the header as Modbus and notice that it lists register 360. Because this parameter is a float it is actually represented by registers 360 (low order bytes) and 361 (high order bytes). Because the Modbus specification does not dictate which register should be high or low order Watlow provides the user the ability to swap this order (Setup Page, Menu) from the default low/high to high/low .

## Note:

With the release of firmware revision 7.00 and above new functions were introduced into this product line. With the introduction of these new functions there was a reorganization of Modbus registers. Notice in the column identified as Mod-

bus the reference to Map 1 and Map 2 registers for each of the various parameters. If the new functions, namely; Linearization, Process Value and Real Time Clock are to be used than use Map 2 Modbus registers. The Data Map **[P7RP]** for Modbus registers can be changed in the Setup Page under the **[CON]** Menu. This setting will apply across the control.

It should also be noted that some of the cells in the Modbus column contain wording pertaining to an offset. Several parameters in the control contain more than one instance; such as, profiles (4), alarms (4), analog inputs (2), etc... The Modbus register shown always represents instance one. Take for an example the Alarm Silence parameter found in the Setup Page under the Alarm menu. Instance one of Map 1 is shown as address 1490 and +50 is identified as the offset to the next instance. If there was a desire to read or write to instance 3 simply add 100 to 1490 to find its address, in this case, the instance 3 address for Alarm Silence is 1590.

To learn more about the Modbus protocol point your browser to <http://www.modbus.org>.

**Note:**

There are two columns shown in the menus that follow for communications protocols identified as CIP (Common Industrial Protocol) and Profibus. These columns will be useful if this control is used in conjunction with the EZ-ZONE Remote User Interface/Gateway (RUI/GTW) where those protocols can be selected as optional hardware. For this control, as a secondary protocol beyond Standard Bus, Modbus RTU can be ordered as optional hardware.

To learn more about the RUI/GTW point your browser to the link below and search for keyword EZ-ZONE.

[http://www.watlow.com/literature/pti\\_search.cfm](http://www.watlow.com/literature/pti_search.cfm)

# 5

## Chapter 5: Operations Page

### Navigating the Operations Page

To go to the Operations Page from the Home Page, press both the Up ▲ and Down ▼ keys for three seconds. **A** will appear in the upper display and **OPER** will appear in the lower display.

- Press the Up ▲ or Down ▼ key to view available menus. On the following pages top level menus are identified with a yellow background color.
- Press the Advance Key ⏩ to enter the menu of choice.
- If a submenu exists (more than one instance), press

the Up ▲ or Down ▼ key to select and then press the Advance Key ⏩ to enter.

- Press the Up ▲ or Down ▼ key to move through available menu prompts.
- Press the Infinity Key ∞ to move backwards through the levels: parameter to submenu; submenu to menu; menu to Home Page.
- Press and hold the Infinity Key ∞ for two seconds to return to the Home Page.

#### Note:

Some of these menus and parameters may not appear, depending on the controller's options. See model number information in the Appendix for more information. If there is only one instance of a menu, no sub-menus will appear.

### Operations Page

<b>A</b>	<b>RES</b> Autotune Set Point
<b>OPER</b> Analog Input Menu	<b>REQ</b> Autotune Request
<b>A</b> Process Value	<b>CLSP</b> Closed Loop Set Point
<b>E</b> Error Status	<b>IS</b> Idle Set Point
<b>CA</b> Calibration Offset	<b>HPB</b> Heat Proportional Band
<b>L</b> *	<b>HH</b> Heat Hysteresis
<b>OPER</b> Linearization Menu	<b>CPB</b> Cool Proportional Band
<b>S</b> Source Value A	<b>CH</b> Cool Hysteresis
<b>OFF</b> Offset	<b>T</b> Time Integral
<b>O</b> Output Value	<b>TD</b> Time Derivative
<b>P</b> *	<b>DB</b> Dead Band
<b>OPER</b> Process Value Menu	<b>OSP</b> Open Loop Set Point
<b>S</b> Source Value A	<b>ALM</b>
<b>OFF</b> Offset	<b>OPER</b> Alarm Menu
<b>O</b> Output Value	<b>1</b> to <b>4</b>
<b>D</b>	<b>ALM</b> Alarm 1
<b>OPER</b> Digital Input/Output Menu	<b>LS</b> Low Set Point
<b>5</b> to <b>6</b>	<b>HS</b> High Set Point
<b>D</b> Digital Input/Output	<b>P</b>
<b>OS</b> Output State	<b>OPER</b> Profile Status Menu
<b>ES</b> Event State	<b>1</b> to <b>4</b>
<b>IS</b> Input State	<b>P</b> Profile Status
<b>M</b>	<b>P</b> Profile Start
<b>OPER</b> Monitor Menu	<b>AR</b> Action Request
<b>CM</b> Control Mode Active	<b>ST</b> Active Step
<b>HP</b> Heat Power	<b>ST</b> Active Step Type
<b>CP</b> Cool Power	<b>ESP</b> Target Set Point Loop 1
<b>CLSP</b> Closed Loop Working Set Point	<b>RLSP</b> Produced Set Point 1
<b>P</b> Process Value Active	<b>hour</b> Hours Remaining
<b>L</b>	<b>min</b> Minutes Remaining
<b>OPER</b> Loop Menu	<b>SEC</b> Seconds Remaining
<b>REN</b> Remote Enable	<b>ENT</b> Active Event Output 1
<b>CM</b> Control Mode	<b>ENT</b> Active Event Output 2
	<b>JC</b> Jump Count Remaining

\* Available with PM4, PM8 and PM9 models only

Operations Page

Display	Parameter Name Description	Range	Default	Modbus Relative Address	CIP Class Instance Attribute hex (dec)	Pro-fibus Index	Parameter ID	Data Type & Read/Write
<b>oPEr</b> <b>Analog Input Menu</b>								
<b>Ain</b> [Ain]	<i>Analog Input (1)</i> <b>Process Value</b> View the process value.	-1,999.000 to 9,999.000°F or units -1,128.000 to 5,537.000°C	----	<b>Instance 1</b> Map 1 Map 2 360 360 <b>Instance 2</b> Map 1 Map 2 440 450	0x68 (104) 1 1	0	4001	float R
<b>iEr</b> [i.Er]	<i>Analog Input (1)</i> <b>Error Status</b> View the cause of the most recent error. If the <b>REEn</b> message is <b>Er.i1</b> or <b>Er.i2</b> , this parameter will display the cause of the input error.	<b>none</b> None (61) <b>OPEn</b> Open (65) <b>FRiL</b> Fail (32) <b>Shrt</b> Shorted (127) <b>Err7</b> Measurement Error (140) <b>ECAL</b> Bad Calibration Data (139) <b>ErAb</b> Ambient Error (9) <b>Ertd</b> RTD Error (141) <b>NSrc</b> Not Sourced (246)	None	<b>Instance 1</b> Map 1 Map 2 362 362 <b>Instance 2</b> Map 1 Map 2 442 452	0x68 (104) 1 2	1	4002	uint R
<b>iCA</b> [i.CA]	<i>Analog Input (1)</i> <b>Calibration Offset</b> Offset the input reading to compensate for lead wire resistance or other factors that cause the input reading to vary from the actual process value.	-1,999.000 to 9,999.000°F or units -1,110.555 to 5,555.000°C	0.0	<b>Instance 1</b> Map 1 Map 2 382 382 <b>Instance 2</b> Map 1 Map 2 462 472	0x68 (104) 1 0xC (12)	2	4012	float RWES
<b>Lnrc*</b> <b>oPEr</b> <b>Linearization Menu</b>								
<b>SuA</b> [Su.A]	<i>Linearization (1)</i> <b>Source Value A</b> View the value of Source A. Source A of Linearization 1 is connected to Analog Input 1	-1,999.000 to 9,999.000°F or units -1,128.000 to 5,537.000°C	----	<b>Instance 1</b> Map 1 Map 2 ---- 3566	0x86 (134) 1 4	----	34004	float R
<b>oFSt</b> [oFSt]	<i>Linearization (1)</i> <b>Offset</b> Set an offset to be applied to this function's output.	-1,999.000 to 9,999.000°F or units -1,128.000 to 5,537.000°C	0	<b>Instance 1</b> Map 1 Map 2 ---- 3570	0x86 (134) 1 6	----	34006	float RWES
<b>oV</b> [o.v]	<i>Linearization (1)</i> <b>Output Value</b> View the value of this function's output.	-1,999.000 to 9,999.000°F or units -1,128.000 to 5,537.000°C	----	<b>Instance 1</b> Map 1 Map 2 ---- 3572	0x86 (134) 1 7	----	34007	float R
<b>Note:</b> Some values will be rounded off to fit in the four-character display. Full values can be read with other interfaces.  * Available with PM4, PM8 and PM9 models only								R: Read W: Write E: EE-PROM S: User Set

Operations Page

Display	Parameter Name Description	Range	Default	Modbus Relative Address	CIP Class Instance Attribute hex (dec)	Pro-fibus Index	Paqram-eter ID	Data Type & Read/Write
No Display	<i>Linearization (1)</i> <b>Output Error</b> View reported cause for Linearization output malfunction.	None (61) Open (65) Shorted (127) Measurement error (140) Bad calibration data (139) Ambient error (9) RTD error (14) Fail (32) Math error (1423) Not sourced (246) Stale (1617) Can't process (1659)	----	<b>Instance 1</b> <i>Map 1 Map 2</i> ---- 3614	0x86 (134) 1 0x1C (28)	----	34028	uint R
<div style="border: 1px solid black; background-color: #ffffcc; padding: 5px;"> <p><b>PU*</b> <b>OPER</b></p> <p><b>Process Value Menu</b></p> </div>								
<input type="checkbox"/> <b>SvA</b> [ Sv.A]	<i>Process Value (1)</i> <b>Source Value A</b> View the value of Source A. Linearization 1 is connected to Source A of Process Value 1	-1,999.000 to 9,999.000°F or units -1,128.000 to 5,537.000°C	----	<b>Instance 1</b> <i>Map 1 Map 2</i> ---- 3310	0x7E (126) 1 0x10 (16)	----	26016	float R
<input type="checkbox"/> <b>oFSt</b> [oFSt]	<i>Process Value (1)</i> <b>Offset</b> Set an offset to be applied to this function's output.	-1,999.000 to 9,999.000°F or units -1,128.000 to 5,537.000°C	0	<b>Instance 1</b> <i>Map 1 Map 2</i> ---- 3324	0x7E (126) 1 0x17 (23)	----	26023	float RWES
<input type="checkbox"/> <b>o.v</b> [ o.v]	<i>Process Value (1)</i> <b>Output Value</b> View the value of this function block's output.	-1,999.000 to 9,999.000°F or units -1,128.000 to 5,537.000°C	----	<b>Instance 1</b> <i>Map 1 Map 2</i> ---- 3322	0x7E (126) 1 0x16 (22)	----	26022	float R
No Display	<i>Process Value (1)</i> <b>Output Error</b> View reported cause for Process output malfunction.	None (61) Open (65) Shorted (127) Measurement error (140) Bad calibration data (139) Ambient error (9) RTD error (14) Fail (32) Math error (1423) Not sourced (246) Stale (1617) Can't process (1659)	----	<b>Instance 1</b> <i>Map 1 Map 2</i> ---- 3332	0x86 (134) 1 to 2 0x1B (27)	----	26027	uint R
<p><b>Note:</b> Some values will be rounded off to fit in the four-character display. Full values can be read with other interfaces.</p> <p>* Available with PM4, PM8 and PM9 models only</p>								R: Read W: Write E: EE- PROM S: User Set

Operations Page

Display	Parameter Name Description	Range	Default	Modbus Rela- tive Address	CIP Class Instance Attribute hex (dec)	Pro- fibus Index	Paqram- eter ID	Data Type & Read/ Write
<div style="border: 1px solid black; padding: 2px;"> <span style="border: 1px solid black; padding: 1px;">d.o</span>  <span style="border: 1px solid black; padding: 1px;">oPEr</span>  <b>Digital Input/Output Menu</b> </div>								
<span style="border: 1px solid black; padding: 1px;">d.o.S</span> [ do.S]	<i>Digital Output (5 to 6)</i> <b>Output State</b> View the state of this out- put.	<span style="border: 1px solid black; padding: 1px;">oFF</span> Off (62) <span style="border: 1px solid black; padding: 1px;">oN</span> On (63)	----	<b>Instance 1</b> <i>Map 1 Map 2</i> 1012 1132 Offset to next instance equals +30	0x6A (106) 1 to 2 7	90	6007	uint R
<span style="border: 1px solid black; padding: 1px;">E.i.S</span> [ Ei.S]	<i>Digital Input (5 to 6)</i> <b>Event Status</b> View this event input state.	<span style="border: 1px solid black; padding: 1px;">iAct</span> Inactive (41) <span style="border: 1px solid black; padding: 1px;">Act</span> Active (5)	----	<b>Instance 1</b> <i>Map 1 Map 2</i> 1328 1568 Offset to next instance equals +20	0x6E (110) 1 to 2 5	140	10005	uint R
No Dis- play	<i>EZ-Key/s (1 to 2)</i> <b>Event Status</b> View this event input state.	<span style="border: 1px solid black; padding: 1px;">iAct</span> Inactive (41) <span style="border: 1px solid black; padding: 1px;">Act</span> Active (5)	----	<b>Instance 1</b> <i>Map 1 Map 2</i> 1368 1608 <b>Instance 2</b> <i>Map 1 Map 2</i> ---- 1628	0x6E (110) 3 to 4 5	140	10005	uint R
<div style="border: 1px solid black; padding: 2px;"> <span style="border: 1px solid black; padding: 1px;">PMon</span>  <span style="border: 1px solid black; padding: 1px;">oPEr</span>  <b>Monitor Menu</b> </div>								
<span style="border: 1px solid black; padding: 1px;">C.P.A</span> [ C.MA]	<i>Monitor (1)</i> <b>Control Mode Active</b> View the current control mode.	<span style="border: 1px solid black; padding: 1px;">oFF</span> Off (62) <span style="border: 1px solid black; padding: 1px;">Auto</span> Auto (10) <span style="border: 1px solid black; padding: 1px;">PMon</span> Manual (54)	Off	<b>Instance 1</b> <i>Map 1 Map 2</i> 1882 2362	0x97 (151) 1 2	----	8002	uint R
<span style="border: 1px solid black; padding: 1px;">h.Pr</span> [ h.Pr]	<i>Monitor (1)</i> <b>Heat Power</b> View the current heat out- put level.	0.0 to 100.0%	0.0	<b>Instance 1</b> <i>Map 1 Map 2</i> 1904 2384	0x97 (151) 1 0xD (13)	----	8011	float R
<span style="border: 1px solid black; padding: 1px;">C.Pr</span> [ C.Pr]	<i>Monitor (1)</i> <b>Cool Power</b> View the current cool out- put level.	-100.0 to 0.0%	0.0	<b>Instance 1</b> <i>Map 1 Map 2</i> 1906 2386	0x97 (151) 1 0xE (14)	----	8014	float R
<span style="border: 1px solid black; padding: 1px;">C.SP</span> [ C.SP]	<i>Monitor (1)</i> <b>Closed Loop Working Set Point</b> View the set point cur- rently in effect.	-1,999.000 to 9,999.000°F or units -1,128.000 to 5,537.000°C	----	<b>Instance 1</b> <i>Map 1 Map 2</i> 2172 2652	0x6B (107) 1 7	----	8029	float R
<span style="border: 1px solid black; padding: 1px;">P.v.A</span> [ Pv.A]	<i>Monitor (1)</i> <b>Process Value Active</b> View the current filtered process value using the control input.	-1,999.000 to 9,999.000°F or units -1,128.000 to 5,537.000°C	----	<b>Instance 1</b> <i>Map 1 Map 2</i> 402 402	0x68 (104) 1 0x16 (22)	----	8031	float R
No Dis- play	<i>Monitor (1)</i> <b>Set Point Active</b> Read the current active set point.	-1,999.000 to 9,999.000°F or units -1,128.000 to 5,537.000°C		<b>Instance 1</b> <i>Map 1 Map 2</i> 2172 2652	0x6B (107) 1 7	----	7018	float R
<b>Note:</b> Some values will be rounded off to fit in the four-character display. Full values can be read with other interfaces.  * Available with PM4, PM8 and PM9 models only								R: Read W: Write E: EE- PROM S: User Set

Operations Page

Display	Parameter Name Description	Range	Default	Modbus Relative Address	CIP Class Instance Attribute hex (dec)	Pro-fibus Index	Paqram-eter ID	Data Type & Read/Write
<b>Loop</b> <b>OPER</b> <b>Control Loop Menu</b>								
<b>[r.En]</b> [ r.En]	<b>Control Loop (1)</b> <b>Remote Enable</b> Enable this loop to switch control to the remote set point.	<b>[no]</b> No <b>[YES]</b> Yes	No	<b>Instance 1</b> <i>Map 1</i> 2200 <i>Map 2</i> 2680	0x6B (107) 1 0x15 (21)	48	7021	uint RWES
<b>[r.ty]</b> [ r.ty]	<b>Control Loop (1)</b> <b>Remote Set Point Type</b> Enable this loop to switch control to the remote set point.	<b>[Auto]</b> Auto (10) <b>[MAN]</b> Manual (54)	No	<b>Instance 1</b> <i>Map 1</i> 2202 <i>Map 2</i> 2682	0x6B (107) 1 0x16 (22)	- - - -	7022	uint RWES
<b>[C.M]</b> [ C.M]	<b>Control Loop (1)</b> <b>Control Mode</b> Select the method that this loop will use to control.	<b>[OFF]</b> Off (62) <b>[Auto]</b> Auto (10) <b>[MAN]</b> Manual (54)	Auto	<b>Instance 1</b> <i>Map 1</i> 1880 <i>Map 2</i> 2360	0x97 (151) 1 1	63	8001	uint RWES
<b>[A.tSP]</b> [A.tSP]	<b>Control Loop (1)</b> <b>Autotune Set Point</b> Set the set point that the autotune will use, as a percentage of the current set point.	50.0 to 200.0%	90.0	<b>Instance 1</b> <i>Map 1</i> 1998 <i>Map 2</i> 2398	0x97 (151) 1 0x14 (20)	- - - -	8025	float RWES
<b>[AUt]</b> [ AUt]	<b>Control Loop (1)</b> <b>Autotune Request</b> Start an autotune. While the autotune is active, the Home Page will display <b>[Auto]</b> <b>[Auto]</b> . When the autotune is complete, the message will clear automatically.	<b>[no]</b> No (59) <b>[YES]</b> Yes (106)	No	<b>Instance 1</b> <i>Map 1</i> 1920 <i>Map 2</i> 2400	0x97 (151) 1 0x15 (21)	64	8026	uint RW
<b>[C.SP]</b> [ C.SP]	<b>Control Loop (1)</b> <b>Closed Loop Set Point</b> Set the set point that the controller will automatically control to.	Low Set Point to High Set Point (Setup Page)	75.0°F or units 24.0°C	<b>Instance 1</b> <i>Map 1</i> 2160 <i>Map 2</i> 2640	0x6B (107) 1 1	49	7001	float RWES
<b>[id.S]</b> [ id.S]	<b>Control Loop (1)</b> <b>Idle Set Point</b> Set a closed loop set point that can be triggered by an event state.	Low Set Point to High Set Point (Setup Page)	75.0°F or units 24.0°C	<b>Instance 1</b> <i>Map 1</i> 2176 <i>Map 2</i> 2656	0x6B (107) 1 9	50	7009	float RWES
<b>[h.Pb]</b> [ h.Pb]	<b>Control Loop (1)</b> <b>Heat Proportional Band</b> Set the PID proportional band for the heat outputs.	0.001 to 9,999.000°F or units -1,110.555 to 5,555.000°C	25.0°F or units 14.0°C	<b>Instance 1</b> <i>Map 1</i> 1890 <i>Map 2</i> 2370	0x97 (151) 1 6	65	8009	float RWES
<b>[h.hy]</b> [ h.hy]	<b>Control Loop (1)</b> <b>Heat Hysteresis</b> Set the control switching hysteresis for on-off control. This determines how far into the “on” region the process value needs to move before the output turns on.	0.001 to 9,999.000°F or units -1,110.555 to 5,555.000°C	3.0°F or units 2.0°C	<b>Instance 1</b> <i>Map 1</i> 1900 <i>Map 2</i> 2380	0x97 (151) 1 0xB (11)	66	8010	float RWES
<b>Note:</b> Some values will be rounded off to fit in the four-character display. Full values can be read with other interfaces.  * Available with PM4, PM8 and PM9 models only								R: Read W: Write E: EE-PROM S: User Set



Operations Page

Display	Parameter Name Description	Range	Default	Modbus Relative Address	CIP Class Instance Attribute hex (dec)	Pro-fibus Index	Paqram-eter ID	Data Type & Read/Write
<input type="checkbox"/> <b>C.Pb</b> [ C.Pb]	<i>Control Loop (1)</i> <b>Cool Proportional Band</b> Set the PID proportional band for the cool outputs.	0.001 to 9,999.000°F or units -1,110.555 to 5,555.000°C	25.0°F or units 14.0°C	<b>Instance 1</b> <i>Map 1</i> <i>Map 2</i> 1892 2370	0x97 (151) 1 7	67	8012	float RWES
<input type="checkbox"/> <b>C.hy</b> [ C.hy]	<i>Control Loop (1)</i> <b>Cool Hysteresis</b> Set the control switching hysteresis for on-off control. This determines how far into the “on” region the process value needs to move before the output turns on.	0.001 to 9,999.000°F or units -1,110.555 to 5,555.000°C	3.0°F or units 2.0°C	<b>Instance 1</b> <i>Map 1</i> <i>Map 2</i> 1902 2382	0x97 (151) 1 0xC (12)	68	8013	float RWES
<input type="checkbox"/> <b>t.</b> [ ti]	<i>Control Loop (1)</i> <b>Time Integral</b> Set the PID integral for the outputs.	0 to 9,999 seconds per repeat	180.0 seconds per repeat	<b>Instance 1</b> <i>Map 1</i> <i>Map 2</i> 1894 2374	0x97 (151) 1 8	69	8006	float RWES
<input type="checkbox"/> <b>td</b> [ td]	<i>Control Loop (1)</i> <b>Time Derivative</b> Set the PID derivative time for the outputs.	0 to 9,999 seconds	0.0 seconds	<b>Instance 1</b> <i>Map 1</i> <i>Map 2</i> 1896 2376	0x97 (151) 1 9	70	8007	float RWES
<input type="checkbox"/> <b>db</b> [ db]	<i>Control Loop (1)</i> <b>Dead Band</b> Set the offset to the proportional band. With a negative value, both heating and cooling outputs are active when the process value is near the set point. A positive value keeps heating and cooling outputs from fighting each other.	-1,000.0 to 1,000.0°F or units -556 to 556°C	0.0	<b>Instance 1</b> <i>Map 1</i> <i>Map 2</i> 1898 2378	0x97 (151) 1 0xA (10)	71	8008	float RWES
<input type="checkbox"/> <b>o.SP</b> [ o.SP]	<i>Control Loop (1)</i> <b>Open Loop Set Point</b> Set a fixed level of output power when in manual (open-loop) mode.	-100 to 100% (heat and cool) 0 to 100% (heat only) -100 to 0% (cool only)	0.0	<b>Instance 1</b> <i>Map 1</i> <i>Map 2</i> 2162 2642	0x6B (107) 1 2	51	7002	float RWES
No Display	<i>Control Loop (1)</i> <b>Loop Error</b> Open Loop detect deviation has been exceeded.	None (61) Open Loop (1274) Reversed Sensor (1275)	----	<b>Instance 1</b> <i>Map 1</i> <i>Map 2</i> ---- 1798	0x6C (108) 1 0x30 (48)	----	8030	uint R
No Display	<i>Control Loop (1)</i> <b>Clear Loop Error</b> Current state of limit output.	Clear (129) Ignore (204)	----	<b>Instance 1</b> <i>Map 1</i> <i>Map 2</i> ---- 1800	0x6C (108) 1 0x31 (49)	----	8031	uint W
<b>Note:</b> Some values will be rounded off to fit in the four-character display. Full values can be read with other interfaces.  * Available with PM4, PM8 and PM9 models only								R: Read W: Write E: EE-PROM S: User Set

Operations Page

Display	Parameter Name Description	Range	Default	Modbus Relative Address	CIP Class Instance Attribute hex (dec)	Pro-fibus Index	Paqram-eter ID	Data Type & Read/Write
<div style="border: 1px solid black; padding: 2px;"> <span style="border: 1px solid black; padding: 1px;">RLC</span> <span style="border: 1px solid black; padding: 1px;">PE</span> </div> <b>Alarm Menu</b>								
<div style="border: 1px solid black; padding: 2px;"> <span style="border: 1px solid black; padding: 1px;">RL</span> <span style="border: 1px solid black; padding: 1px;">A.Lo</span> </div>	<i>Alarm (1 to 4)</i> <b>Low Set Point</b> If Alarm Type (Setup Page, Alarm Menu) is set to: <b>process</b> - set the process value that will trigger a low alarm. <b>deviation</b> - set the span of units from the closed loop set point that will trigger a low alarm. A negative set point represents a value below closed loop set point. A positive set point represents a value above closed loop set point.	-1,999.000 to 9,999.000°F or units -1,128.000 to 5,537.000°C	32.0°F or units 0.0°C	<b>Instance 1</b> <i>Map 1</i> <i>Map 2</i> 1482   1882  Offset to next instance ( <i>Map 1</i> ) equals +50  Offset to next instance ( <i>Map 2</i> ) equals +60	0x6D (109) 1 to 4 2	18	9002	float RWES
<div style="border: 1px solid black; padding: 2px;"> <span style="border: 1px solid black; padding: 1px;">Rh</span> <span style="border: 1px solid black; padding: 1px;">A.hi</span> </div>	<i>Alarm (1 to 4)</i> <b>High Set Point</b> If Alarm Type (Setup Page, Alarm Menu) is set to: <b>process</b> - set the process value that will trigger a high alarm. <b>deviation</b> - set the span of units from the closed loop set point that will trigger a high alarm.	-1,999.000 to 9,999.000°F or units -1,128.000 to 5,537.000°C	300.0°F or units 150.0°C	<b>Instance 1</b> <i>Map 1</i> <i>Map 2</i> 1480   1880  Offset to next instance ( <i>Map 1</i> ) equals +50  Offset to next instance ( <i>Map 2</i> ) equals +60	0x6D (109) 1 to 4 1	19	9001	float RWES
No Displayed	<i>Alarm (1 to 4)</i> <b>Alarm State</b> Current state of alarm	Startup (88) None (61) Blocked (12) Alarm low (8) Alarm high (7) Error (28)	None	<b>Instance 1</b> <i>Map 1</i> <i>Map 2</i> 1496   1896  Offset to next instance [ <i>Map 1</i> +50], [ <i>Map 2</i> +60]	0x6D (109) 1 to 4 9	----	9009	uint R
No Displayed	<i>Alarm (1 to 4)</i> <b>Alarm Clearable</b> Current state of alarm	No (59) Yes (106)	----	<b>Instance 1</b> <i>Map 1</i> <i>Map 2</i> 1502   1902  Offset to next instance ( <i>Map 1</i> ) equals +50, <i>Map 2</i> equals +60)	0x6D (109) 1 to 4 0xC (12)	----	9012	uint R
<b>Note:</b> Some values will be rounded off to fit in the four-character display. Full values can be read with other interfaces.  * Available with PM4, PM8 and PM9 models only								R: Read W: Write E: EE-PROM S: User Set

Operations Page

Display	Parameter Name Description	Range	Default	Modbus Relative Address	CIP Class Instance Attribute hex (dec)	Pro-fibus Index	Paqram-eter ID	Data Type & Read/Write
No Dis- played	<i>Alarm (1 to 4)</i> <b>Alarm Clear Request</b> Write to this register to clear an alarm	Clear (1003)	0	<b>Instance 1</b> <i>Map 1</i> <i>Map 2</i> 1504 1904  Offset to next instance (Map1 1 equals +50, <i>Map 2</i> equals +60)	0x6D (109) 1 to 4 0xD (13)	----	9013	uint W
No Dis- played	<i>Alarm (1 to 4)</i> <b>Alarm Silence Request</b> Write to this register to silence an alarm	Silence (1010)	0	<b>Instance 1</b> <i>Map 1</i> <i>Map 2</i> 1506 1906  Offset to next instance (Map1 1 equals +50, <i>Map 2</i> equals +60)	0x6D (109) 1 to 4 0xE (14)	----	9014	uint W
No Dis- played	<i>Alarm (1 to 4)</i> <b>Alarm Silenced</b> Write to this register to silence an alarm	Yes (106) No (59)	----	<b>Instance 1</b> <i>Map 1</i> <i>Map 2</i> 1500 1900  Offset to next instance (Map1 1 equals +50, <i>Map 2</i> equals +60)	0x6D (109) 1 to 4 0xB (11)	----	9011	uint R
No Dis- played	<i>Alarm (1 to 4)</i> <b>Alarm Latched</b> Write to this register to silence an alarm	Yes (106) No (59)	----	<b>Instance 1</b> <i>Map 1</i> <i>Map 2</i> 1498 1898  Offset to next instance (Map1 1 equals +50, <i>Map 2</i> equals +60)	0x6D (109) 1 to 4 0xA (10)	----	9010	uint R
<b>OPER</b> <b>OPER</b> <b>Profile Status Menu</b>  Profile Menu appears if: (PM _ [R, B*, N, E*] _ _ _ _ _ _ _ _ )				* Available with PM8/9 only * Some parameters in the Profile Status Menu can be changed for the currently running profile, but should only be changed by knowledgeable personnel and with caution. Changing parameters via the Profile Status Menu will not change the stored profile but will have an immediate impact on the profile that is running. Changes made to profile parameters in the Profiling Pages will be saved and will also have an immediate impact on the running profile.				
<b>OPER</b> [P.Str]	<i>Profile Status</i> <b>Profile Start</b> Select step to act upon.	1 to 40	1	<b>Instance 1</b> <i>Map 1</i> <i>Map 2</i> 2520 4340	0x7A (122) 1 1	204	22001	uint RW
<b>Note:</b> Some values will be rounded off to fit in the four-character display. Full values can be read with other interfaces.  * Available with PM4, PM8 and PM9 models only				<b>R: Read</b> <b>W: Write</b> <b>E: EE-PROM</b> <b>S: User Set</b>				

Operations Page

Display	Parameter Name Description	Range	Default	Modbus Relative Address	CIP Class Instance Attribute hex (dec)	Profibus Index	Parameter ID	Data Type & Read/Write
<b>PRCr</b> [PACr]	<i>Profile Status</i> <b>Action Request</b>	<b>none</b> None (61) <b>STEP</b> Step Start (89) <b>End</b> Terminate (148) <b>RESU</b> Resume (147) <b>PAUS</b> Pause (146) <b>PROF</b> Profile (77)	None	<b>Instance 1</b> <i>Map 1 Map 2</i> 2540 4360	0x7A (122) 1 0xB (11)	205	22011	uint RW
<b>STP</b> [StP]	<i>Profile Status</i> <b>Active Step</b> View the currently running step.	1 to 40	0 (none)	<b>Instance 1</b> <i>Map 1 Map 2</i> 2526 4346	0x7A (122) 1 4	----	22004	uint R
<b>STYP</b> [S.typ]	<i>Profile Status</i> <b>Active Step Type</b> View the currently running step type.	<b>USEP</b> Unused Step (50) <b>End</b> End (27) <b>JL</b> Jump Loop (116) <b>CLoC</b> Wait For Time (1543) <b>UJbo</b> Wait For Both (210) <b>UJPr</b> Wait For Process (209) <b>UJE</b> Wait For Event (144) <b>SoRH</b> Soak (87) <b>t</b> Time (143) <b>rRtE</b> Rate (81)	----	<b>Instance 1</b> <i>Map 1 Map 2</i> 2544 4364	0x7A (122) 1 0xD (13)	----	22013	uint R
<b>TSPI</b> [tg.SP]	<i>Profile Status</i> <b>*Target Set Point Loop 1</b> View or change the target set point of the current step.	-1,999.000 to 9,999.000°F or units -1,128.000 to 5,537.000°C	0.0°F or units -18.0°C	<b>Instance 1</b> <i>Map 1 Map 2</i> 2542 4502	0x7A (122) 1 0xC (12)	----	22012	uint RW
<b>ACSP</b> [AC.SP]	<i>Profile Status</i> <b>Produced Set Point 1</b> Display the current set point, even if the profile is ramping.	-1,999.000 to 9,999.000°F or units -1,128.000 to 5,537.000°C	0.0°F or units -18.0°C	<b>Instance 1</b> <i>Map 1 Map 2</i> ----	----	----	22005	float R
<b>hoUr</b> [hoUr]	<i>Profile Status</i> <b>Hours</b> Step time remaining in hours.	0 to 99	0	<b>Instance 1</b> <i>Map 1 Map 2</i> ---- 4494	0x7A (122) 1 0x4E (78)	----	22078	uint RW
<b>Min</b> [Min]	<i>Profile Status</i> <b>Minutes</b> Step time remaining in minutes.	0 to 59	0	<b>Instance 1</b> <i>Map 1 Map 2</i> ---- 4492	0x7A (122) 1 0x4D (77)	----	22077	uint RW
<b>SEC</b> [SEC]	<i>Profile Status</i> <b>Seconds</b> Step time remaining in seconds.	0 to 59	0	<b>Instance 1</b> <i>Map 1 Map 2</i> ---- 4490	0x7A (122) 1 0x4C (76)	----	22076	uint RW
<b>Ent1</b> [Ent1]	<i>Profile Status</i> <b>Active Event Output 1</b> View or change the event output states.	<b>oFF</b> Off (62) <b>on</b> On (63)	Off	<b>Instance 1</b> <i>Map 1 Map 2</i> 2546 4512	0x7A (122) 1 0xE (14)	----	22014	uint RW
<p><b>Note:</b> Some values will be rounded off to fit in the four-character display. Full values can be read with other interfaces.</p> <p>* Available with PM4, PM8 and PM9 models only</p>								R: Read W: Write E: EE-PROM S: User Set



Operations Page

Display	Parameter Name Description	Range	Default	Modbus Rela- tive Address	CIP Class Instance Attribute hex (dec)	Pro- fibus Index	Paqram- eter ID	Data Type & Read/ Write
<b>[Ent2]</b> [Ent2]	<i>Profile Status</i> <b>Active Event Output 2</b> View or change the event output states.	<input type="checkbox"/> <b>OFF</b> Off (62) <input type="checkbox"/> <b>ON</b> On (63)	Off	<b>Instance 1</b> <i>Map 1 Map 2</i> 2548 4514	0x7A (122) 1 0xF (15)	----	22015	uint RW
<b>[JC]</b> [ JC]	<i>Profile Status</i> <b>Jump Count Remaining</b> View the jump counts remaining for the current loop. In a profile with nested loops, this may not indicate the actual jump counts remaining.	0 to 9,999	0	<b>Instance 1</b> <i>Map 1 Map 2</i> 2538 4358	0x7A (122) 1 0xA (10)	----	22010	uint R
No Dis- play	<i>Profile Status</i> <b>Profile State</b> Read currentProfile state.	off (62) Running (149) Pause (146)	----	<b>Instance 1</b> <i>Map 1 Map 2</i> 2522 4342	0x7A (122) 1 2	----	22002	uint R
No Dis- play	<i>Profile Status</i> <b>Current File</b> Indicates current file being executed.	1 to 4	0	<b>Instance 1</b> <i>Map 1 Map 2</i> 2524 4344	0x7A (122) 1 3	----	22003	uint R
<b>Note:</b> Some values will be rounded off to fit in the four-character display. Full values can be read with other interfaces.  * Available with PM4, PM8 and PM9 models only								R: Read W: Write E: EE- PROM S: User Set



# 6

## Chapter 6: Setup Page





### Navigating the Setup Page

To go to the Setup Page from the Home Page, press both the Up  and Down  keys for six seconds.

**A** will appear in the upper display and **SEE** will appear in the lower display.

- Press the Up  or Down  key to view available menus. On the following pages top level menus are identified with a yellow background color.
- Press the Advance Key  to enter the menu of choice.
- If a submenu exists (more than one instance),

press the Up  or Down  key to select and then press the Advance Key  to enter.

- Press the Up  or Down  key to move through available menu prompts.
- Press the Infinity Key  to move backwards through the levels: parameter to submenu; submenu to menu; menu to Home Page.
- Press and hold the Infinity Key  for two seconds to return to the Home Page.

#### Note:

Some of these menus and parameters may not appear, depending on the controller's options. See model number information in the Appendix for more information. If there is only one instance of a menu, no sub-menus will appear.

**A**  
**SEE** Analog Input Menu  
**SEN** Sensor Type  
**LIN** Linearization  
**RTL** RTD Leads  
**UNIT** Units  
**SL0** Scale Low  
**SH1** Scale High  
**RL0** Range Low  
**RH1** Range High  
**PEE** Process Error Enable  
**PEL** Process Error Low  
**EL** Thermistor Curve  
**RR** Resistance Range  
**FIL** Filter  
**LER** Error Latching  
**DEL** Display Precision

**LNR\***  
**SEE** Linearization Menu  
**FN** Function  
**UNIT** Units  
**IP1** Input Point 1  
**OP1** Output Point 1  
**IP2** Input Point 2  
**OP2** Output Point 2  
**IP3** Input Point 3  
**OP3** Output Point 3  
**IP4** Input Point 4  
**OP4** Output Point 4  
**IP5** Input Point 5  
**OP5** Output Point 5  
**IP6** Input Point 6  
**OP6** Output Point 6  
**IP7** Input Point 7  
**OP7** Output Point 7  
**IP8** Input Point 8  
**OP8** Output Point 8  
**IP9** Input Point 9  
**OP9** Output Point 9  
**IP10** Input Point 10

**OP10** Output Point 10  
**PV\***  
**SEE** Process Value  
**FN** Function  
**PUNIT** Pressure Units  
**RUNIT** Altitude Units  
**FIL** Filter  
**DI0**  
**SEE** Digital Input/Output Menu  
**DI0** Digital Input/Output  
**DIR** Direction  
**FN** Function  
**F** Function Instance  
**CTL** Control  
**TB** Time Base  
**LS0** Low Power Scale  
**HS1** High Power Scale

**LOOP**  
**SEE** Control Loop Menu  
**HAG** Heat Algorithm  
**CAG** Cool Algorithm  
**CCR** Cool Output Curve  
**TTUN** Tru-Tune+™ Enable  
**TBND** Tru-Tune+™ Band  
**EGN** Tru-Tune+™ Gain  
**TAAR** Autotune Aggressiveness  
**PDL** Peltier Delay  
**UFA** User Failure Action  
**FRIL** Input Error Failure  
**MAN** Manual Power  
**LDE** Open Loop Detect Enable  
**LDT** Open Loop Detect Time  
**LDD** Open Loop Detect Deviation  
**RP** Ramp Action  
**RS** Ramp Scale  
**RR** Ramp Rate  
**LSP** Low Set Point  
**HSP** High Set Point  
**SPLO** Set Point Open Limit Low

**SPH** Set Point Open Limit High  
**OPPE**  
**SEE** Output Menu  
**I** to **2**  
**OPPE** Output  
**FN** Function  
**F** Function Instance  
**CTL** Control  
**TB** Time Base  
**LS0** Low Power Scale  
**HS1** High Power Scale  
**OPPE** Output 1 process  
**TY** Type  
**FN** Function  
**F** Function Instance  
**SL0** Scale Low  
**SH1** Scale High  
**RL0** Range Low  
**RH1** Range High  
**LS0** Power Scale Low  
**HS1** Power Scale High  
**CAL** Calibration Offset

**ALM**  
**SEE** Alarm Menu  
**I** to **4**  
**ALM** Alarm  
**TY** Type  
**SFA** Source Function A  
**HY** Hysteresis  
**RLG** Logic  
**RS** Sides  
**RLA** Latching  
**RLB** Blocking  
**RS** Silencing  
**RDSP** Display  
**RDL** Delay

**FUN**  
**SEE** Function Key Menu  
**I** to **2**  
**FUN** Function Key

\* Available with PM4, PM8 and PM9 models only

- LEu** Level
- F<sub>n</sub>** Digital Input Function
- F<sub>i</sub>** Instance

**9LbL**

**SEt** Global Menu

- C<sub>-</sub>F** Display Units
- RLf** AC Line Frequency
- r<sub>t</sub>YP** Ramping Type
- P<sub>t</sub>YP** Profile type
- gSE** Guaranteed Soak Enable
- gSd1** Guaranteed Soak Deviation 1
- S<sub>a</sub>** Source instance A
- S<sub>b</sub>** Source instance B
- P<sub>o</sub>t** Power Out Time
- CLED** Communications LED Action
- Z<sub>o</sub>nE** Zone Action
- ChRn** Channel Action
- dPrS** Display Pairs
- d<sub>t</sub>** Menu Display Timer
- USrS** User Save
- USrR** User Restore

**COPn**

**SEt** Communications Menu

- P<sub>C</sub>oL** Protocol
- R<sub>d</sub>S** Standard Bus Address
- R<sub>d</sub>Ad** Modbus Address
- bRUD** Baud Rate
- PRr** Parity
- r<sub>o</sub>hL** Modbus Word Order
- r<sub>o</sub>RP** Data Map
- C<sub>-</sub>F** Display Units
- n<sub>u</sub>S** Non-volatile Save

**r<sub>t</sub>C\***

**SEt** Real Time Clock Menu

- h<sub>o</sub>U<sub>r</sub>** Hour
- r<sub>o</sub>Min** Minute
- d<sub>o</sub>W** Day of Week

\* Available with PM8 and PM9 models only

Setup Page

Display	Parameter Name Description	Range	Default	Modbus Relative Address	CIP Class Instance Attribute hex (dec)	Pro-fibus Index	Parameter ID	Data Type & Read/Write
<div style="border: 1px solid black; padding: 2px;"> <input type="checkbox"/> R  <input type="checkbox"/> SEE  <b>Analog Input Menu</b> </div>								
<input type="checkbox"/> SEN [ SEn]	<b>Analog Input (1)</b> <b>Sensor Type</b> Set the analog sensor type to match the device wired to this input.  <b>Note:</b> There is no open-sensor detection for process inputs.	<input type="checkbox"/> OFF Off (62) <input type="checkbox"/> TC Thermocouple (95) <input type="checkbox"/> MV Millivolts (56) <input type="checkbox"/> VDC Volts dc (104) <input type="checkbox"/> MA Milliamps dc (112) <input type="checkbox"/> RTD100 RTD 100 Ω (113) <input type="checkbox"/> RTD1000 RTD 1,000 Ω (114) <input type="checkbox"/> POT Potentiometer 1 kΩ (155) <input type="checkbox"/> THER Thermistor (229)		<b>Instance 1</b> Map 1    Map 2 368       368	0x68 (104) 1 5	3	4005	uint RWES
<input type="checkbox"/> LIN [ Lin]	<b>Analog Input (1)</b> <b>Linearization</b> Set the linearization to match the thermocouple wired to this input.	<input type="checkbox"/> B B (11) <input type="checkbox"/> H K (48) <input type="checkbox"/> C C (15) <input type="checkbox"/> N N (58) <input type="checkbox"/> D D (23) <input type="checkbox"/> R R (80) <input type="checkbox"/> E E (26) <input type="checkbox"/> S S (84) <input type="checkbox"/> F F (30) <input type="checkbox"/> T T (93) <input type="checkbox"/> J J (46)	J	<b>Instance 1</b> Map 1    Map 2 370       370	0x68 (104) 1 6	4	4006	uint RWES
<input type="checkbox"/> RTL [ rt.L]	<b>Analog Input (1)</b> <b>RTD Leads</b> Set to match the number of leads on the RTD wired to this input.	<input type="checkbox"/> 2 2 (1) <input type="checkbox"/> 3 3 (2)	2	<b>Instance 1</b> Map 1    Map 2 372       368	0x68 (104) 1 7	----	4007	uint RWES
<input type="checkbox"/> UNIT [Unit]	<b>Analog Input (1)</b> <b>Units</b> Set the type of units the sensor will measure.	<input type="checkbox"/> RTP Absolute Temperature (1540) <input type="checkbox"/> RH Relative Humidity (1538) <input type="checkbox"/> PRO Process (75) <input type="checkbox"/> PLUR Power (73)	Process	<b>Instance 1</b> Map 1    Map 2 ----      442	0x68 (104) 1 0x2A (42)	5	4042	uint RWES
<input type="checkbox"/> SLO [ S.Lo]	<b>Analog Input (1)</b> <b>Scale Low</b> Set the low scale for process inputs. This value, in millivolts, volts or milliamps, will correspond to the Range Low output of this function block.	-100.0 to 1,000.0	0.0	<b>Instance 1</b> Map 1    Map 2 388       388	0x68 (104) 1 0xF (15)	6	4015	float RWES
<input type="checkbox"/> SHI [ S.hi]	<b>Analog Input (1)</b> <b>Scale High</b> Set the high scale for process inputs. This value, in millivolts, volts or milliamps, will correspond to the Range High output of this function block.	-100.0 to 1,000.0	20.0	<b>Instance 1</b> Map 1    Map 2 390       390	0x68 (104) 1 0x10 (16)	7	4016	float RWES
<input type="checkbox"/> RLO [ r.Lo]	<b>Analog Input (1)</b> <b>Range Low</b> Set the low range for this function block's output.	-1,999.000 to 9,999.000	0.0	<b>Instance 1</b> Map 1    Map 2 392       392	0x68 (104) 1 0x11 (17)	8	4017	float RWES
<b>Note:</b> Some values will be rounded off to fit in the four-character display. Full values can be read with other interfaces.  * Available with PM4, PM8 and PM9 models only								R: Read W: Write E: EE-PROM S: User Set



Setup Page

Display	Parameter Name Description	Range	Default	Modbus Relative Address	CIP Class Instance Attribute hex (dec)	Pro- fibus Index	Param- eter ID	Data Type & Read/ Write
<input type="checkbox"/> r.hi [ r.hi]	<i>Analog Input (1)</i> <b>Range High</b> Set the high range for this function block's output.	-1,999.000 to 9,999.000	9,999	<b>Instance 1</b> Map 1    Map 2 394       394	0x68 (104) 1 0x12 (18)	9	4018	float RWES
<input type="checkbox"/> P.EE [ P.EE]	<i>Analog Input (1)</i> <b>Process Error Enable</b> Turn the Process Error Low feature on or off.	<input type="checkbox"/> OFF Off (62) <input type="checkbox"/> Low Low (53)	Off	<b>Instance 1</b> Map 1    Map 2 418       388	0x68 (104) 1 0x1E (30)	10	4030	uint RWES
<input type="checkbox"/> P.EL [ P.EL]	<i>Analog Input (1)</i> <b>Process Error Low</b> If the process value drops below this value, it will trigger an input error.	-100.0 to 1,000.0	0.0	<b>Instance 1</b> Map 1    Map 2 420       420	0x68 (104) 1 0x1F (31)	11	4031	float RWES
<input type="checkbox"/> t.C [ t.C]	<i>Analog Input (1)</i> <b>Thermistor Curve</b> Select a curve to apply to the thermistor input.	<input type="checkbox"/> A Curve A (1451) <input type="checkbox"/> B Curve B (1452) <input type="checkbox"/> C Curve C (1453) <input type="checkbox"/> USE Custom (180)	Curve A	<b>Instance 1</b> Map 1    Map 2 434       434	0x68 (104) 1 20x6 (38)	- - - -	4038	uint RWES
<input type="checkbox"/> r.r [ r.r]	<i>Analog Input (1)</i> <b>Resistance Range</b> Set the maximum resistance of the thermistor input.	<input type="checkbox"/> 5 5K (1448) <input type="checkbox"/> 10 10K (1360) <input type="checkbox"/> 20 20K (1361) <input type="checkbox"/> 40 40K (1449)	40K	<b>Instance 1</b> Map 1    Map 2 432       432	0x68 (104) 1 0x25 (37)	- - - -	4037	uint RWES
<input type="checkbox"/> FiL [ FiL]	<i>Analog Input (1)</i> <b>Filter</b> Filtering smooths out the process signal to both the display and the input. Increase the time to increase filtering.	0.0 to 60.0 seconds	0.5	<b>Instance 1</b> Map 1    Map 2 386       386	0x68 (104) 1 0xE (14)	12	4014	float RWES
<input type="checkbox"/> i.Er [ i.Er]	<i>Analog Input (1)</i> <b>Error Latching</b> Turn input error latching on or off. If latching is on, errors must be manually cleared.	<input type="checkbox"/> OFF Off (62) <input type="checkbox"/> On On (63)	Off	<b>Instance 1</b> Map 1    Map 2 414       414	0x68 (104) 1 0x1C (28)	- - - -	4028	uint RWES
<input type="checkbox"/> dEC [ dEC]	<i>Analog Input (1)</i> <b>Display Precision</b> Set the precision of the displayed value.	<input type="checkbox"/> Whole (105) <input type="checkbox"/> .00 Tenths (94) <input type="checkbox"/> .000 Hundredths (40) <input type="checkbox"/> .0000 Thousandths (96)	Whole	<b>Instance 1</b> Map 1    Map 2 398       398	0x68 (104) 1 0x14 (20)	- - - -	4020	uint RWES
<input type="checkbox"/> Lnr* <input type="checkbox"/> SEE <b>Linearization Menu</b>								
<input type="checkbox"/> Fn [ Fn]	<i>Linearization (1)</i> <b>Function</b> Set how this function will linearize Source A which is Analog Input 1.	<input type="checkbox"/> OFF Off (62) <input type="checkbox"/> Inter Interpolated (1482)	Off	<b>Instance 1</b> Map 1    Map 2 - - - -    3568	0x86 (134) 1 5	155	34005	uint RWES
<b>Note:</b> Some values will be rounded off to fit in the four-character display. Full values can be read with other interfaces.  * Available with PM4, PM8 and PM9 models only								R: Read W: Write E: EE-PROM S: User Set

Setup Page

Display	Parameter Name Description	Range	Default	Modbus Relative Address	CIP Class Instance Attribute hex (dec)	Profibus Index	Parameter ID	Data Type & Read/Write
<b>[Unit]</b> [Unit]	<i>Linearization (1)</i> <b>Units</b> Set the units of Source A which is Analog Input 1.	<b>None</b> None (61) <b>Src</b> Source (1539) <b>rh</b> Relative Humidity (1538) <b>Pro</b> Process (75) <b>PLU</b> Power (73) <b>rTP</b> Relative Temperature (1541) <b>ATP</b> Absolute Temperature (1540)	Source	<b>Instance 1</b> Map 1    Map 2 ----    3616	0x86 (134) 1 0x29 (41)	156	34029	uint RWES
<b>[ ip.1]</b> [ ip.1]	<i>Linearization (1)</i> <b>Input Point 1</b> Set the value that will be mapped to output 1.	-1,999.000 to 9,999.000	0.0	<b>Instance 1</b> Map 1    Map 2 ----    3574	0x86 (134) 1 8	157	34008	float RWES
<b>[ op.1]</b> [ op.1]	<i>Linearization (1)</i> <b>Output Point 1</b> Set the value that will be mapped to input 1.	-1,999.000 to 9,999.000	0.0	<b>Instance 1</b> Map 1    Map 2 ----    3594	0x86 (134) 1 0x12 (18)	158	34018	float RWES
<b>[ ip.2]</b> [ ip.2]	<i>Linearization (1)</i> <b>Input Point 2</b> Set the value that will be mapped to output 2.	-1,999.000 to 9,999.000	1.0	<b>Instance 1</b> Map 1    Map 2 ----    3576	0x86 (134) 1 9	159	34009	float RWES
<b>[ op.2]</b> [ op.2]	<i>Linearization (1)</i> <b>Output Point 2</b> Set the value that will be mapped to input 2.	-1,999.000 to 9,999.000	1.0	<b>Instance 1</b> Map 1    Map 2 ----    3597	0x86 (134) 1 0x13 (19)	160	34019	float RWES
<b>[ ip.3]</b> [ ip.3]	<i>Linearization (1)</i> <b>Input Point 3</b> Set the value that will be mapped to output 3.	-1,999.000 to 9,999.000	2.0	<b>Instance 1</b> Map 1    Map 2 ----    3578	0x86 (134) 1 0xA (10)	161	34010	float RWES
<b>[ op.3]</b> [ op.3]	<i>Linearization (1)</i> <b>Output Point 3</b> Set the value that will be mapped to input 3.	-1,999.000 to 9,999.000	2.0	<b>Instance 1</b> Map 1    Map 2 ----    3598	0x86 (134) 1 0x14 (20)	162	34020	float RWES
<b>[ ip.4]</b> [ ip.4]	<i>Linearization (1)</i> <b>Input Point 4</b> Set the value that will be mapped to output 4.	-1,999.000 to 9,999.000	3.0	<b>Instance 1</b> Map 1    Map 2 ----    3581	0x86 (134) 1 0xB (11)	163	34011	float RWES
<b>[ op.4]</b> [ op.4]	<i>Linearization (1)</i> <b>Output Point 4</b> Set the value that will be mapped to input 4.	-1,999.000 to 9,999.000	3.0	<b>Instance 1</b> Map 1    Map 2 ----    3600	0x86 (134) 1 0x15 (21)	164	34021	float RWES
<b>[ ip.5]</b> [ ip.5]	<i>Linearization (1)</i> <b>Input Point 5</b> Set the value that will be mapped to output 5.	-1,999.000 to 9,999.000	4.0	<b>Instance 1</b> Map 1    Map 2 ----    3582	0x86 (134) 1 0xC (12)	165	34012	float RWES
<b>[ op.5]</b> [ op.5]	<i>Linearization (1)</i> <b>Output Point 5</b> Set the value that will be mapped to input 5.	-1,999.000 to 9,999.000	4.0	<b>Instance 1</b> Map 1    Map 2 ----    3602	0x86 (134) 1 0x16 (22)	166	34022	float RWES
<b>Note:</b> Some values will be rounded off to fit in the four-character display. Full values can be read with other interfaces.  * Available with PM4, PM8 and PM9 models only								R: Read W: Write E: EEPROM S: User Set

### Setup Page

Display	Parameter Name Description	Range	Default	Modbus Relative Address	CIP Class Instance Attribute hex (dec)	Pro-fibus Index	Parameter ID	Data Type & Read/Write
<input type="checkbox"/> <b>P.6</b> [ ip.6]	<i>Linearization (1)</i> <b>Input Point 6</b> Set the value that will be mapped to output 6.	-1,999.000 to 9,999.000	5.0	<b>Instance 1</b> Map 1 Map 2 ---- 3584	0x86 (134) 1 0xD (13)	167	34013	float RWES
<input type="checkbox"/> <b>oP.6</b> [ op.6]	<i>Linearization (1)</i> <b>Output Point 6</b> Set the value that will be mapped to input 6.	-1,999.000 to 9,999.000	5.0	<b>Instance 1</b> Map 1 Map 2 ---- 3604	0x86 (134) 1 0x17 (23)	168	34023	float RWES
<input type="checkbox"/> <b>P.7</b> [ ip.7]	<i>Linearization (1)</i> <b>Input Point 7</b> Set the value that will be mapped to output 7.	-1,999.000 to 9,999.000	6.0	<b>Instance 1</b> Map 1 Map 2 ---- 3586	0x86 (134) 1 0xE (14)	169	34014	float RWES
<input type="checkbox"/> <b>oP.7</b> [ op.7]	<i>Linearization (1)</i> <b>Output Point 7</b> Set the value that will be mapped to input 7.	-1,999.000 to 9,999.000	6.0	<b>Instance 1</b> Map 1 Map 2 ---- 3606	0x86 (134) 1 0x18 (24)	170	34024	float RWES
<input type="checkbox"/> <b>P.8</b> [ ip.8]	<i>Linearization (1)</i> <b>Input Point 8</b> Set the value that will be mapped to output 8.	-1,999.000 to 9,999.000	7.0	<b>Instance 1</b> Map 1 Map 2 ---- 3588	0x86 (134) 1 0xF (15)	171	34015	float RWES
<input type="checkbox"/> <b>oP.8</b> [ op.8]	<i>Linearization (1)</i> <b>Output Point 8</b> Set the value that will be mapped to input 8.	-1,999.000 to 9,999.000	7.0	<b>Instance 1</b> Map 1 Map 2 ---- 3608	0x86 (134) 1 0x19 (25)	172	34025	float RWES
<input type="checkbox"/> <b>P.9</b> [ ip.9]	<i>Linearization (1)</i> <b>Input Point 9</b> Set the value that will be mapped to output 9.	-1,999.000 to 9,999.000	8.0	<b>Instance 1</b> Map 1 Map 2 ---- 3590	0x86 (134) 1 0x10 (16)	173	34016	float RWES
<input type="checkbox"/> <b>oP.9</b> [ op.9]	<i>Linearization (1)</i> <b>Output Point 9</b> Set the value that will be mapped to input 9.	-1,999.000 to 9,999.000	8.0	<b>Instance 1</b> Map 1 Map 2 ---- 3610	0x86 (134) 1 0x1A (26)	174	34026	float RWES
<input type="checkbox"/> <b>P.10</b> [ ip.10]	<i>Linearization (1)</i> <b>Input Point 10</b> Set the value that will be mapped to output 10.	-1,999.000 to 9,999.000	9.0	<b>Instance 1</b> Map 1 Map 2 ---- 3592	0x86 (134) 1 0x11 (17)	175	34017	float RWES
<input type="checkbox"/> <b>oP.10</b> [ op.10]	<i>Linearization (1)</i> <b>Output Point 10</b> Set the value that will be mapped to input 10.	-1,999.000 to 9,999.000	9.0	<b>Instance 1</b> Map 1 Map 2 ---- 3612	0x86 (134) 1 0x1B (27)	176	34027	float RWES
<input type="checkbox"/> <b>P.u</b> * <input type="checkbox"/> <b>SEt</b> <b>Process Value Menu</b>								
<input type="checkbox"/> <b>F.n</b> [ Fn]	<i>Process Value (1)</i> <b>Function</b> Set the function that will be applied to the source or sources.	<input type="checkbox"/> <b>oFF</b> Off (62) <input type="checkbox"/> <b>RLt</b> *Pressure to Altitude (1649)	Off	<b>Instance 1</b> Map 1 Map 2 ---- 3320	0x7E (126) 1 0x15 (21)	123	26021	uint RWES
<b>Note:</b> Some values will be rounded off to fit in the four-character display. Full values can be read with other interfaces.  * Available with PM4, PM8 and PM9 models only								R: Read W: Write E: EE-PROM S: User Set

Setup Page

Display	Parameter Name Description	Range	Default	Modbus Relative Address	CIP Class Instance Attribute hex (dec)	Pro-fibus Index	Parameter ID	Data Type & Read/Write
<b>[P.unt]</b> [P.unt]	<i>Process Value (1)</i> <b>Pressure Units*</b> Set the units that will be applied to the source.	<b>PSI</b> Pounds per Square Inch (1671) <b>PASC</b> Pascal (1674) <b>ATM</b> Atmosphere (1675) <b>MILL</b> Millibar (1672) <b>TORR</b> Torr (1673)	PSI	<b>Instance 1</b> <i>Map 1</i> <i>Map 2</i> ---- 3334	0x7E (126) 1 0x1C (28)	----	26028	uint RWES
<b>[A.unt]</b> [A.unt]	<i>Process Value (1)</i> <b>Altitude Units*</b> Set the units that will be applied to the source.	<b>HFT</b> Kilofeet (1677) <b>FEET</b> Feet (1676)	Hft	<b>Instance 1</b> <i>Map 1</i> <i>Map 2</i> ---- 3336	0x7E (126) 1 0x1D (29)	----	26029	uint RWES
<b>[FiL]</b> [FiL]	<i>Process Value (1)</i> <b>Filter</b> Filtering smooths out the output signal of this function block. Increase the time to increase filtering.	0.0 to 60.0 seconds	0.0	<b>Instance 1</b> <i>Map 1</i> <i>Map 2</i> ---- 3330	0x7E (126) 1 0x1A (26)	----	26026	float RWES
<b>[dio]</b> <b>[SEt]</b> <b>Digital Input/Output Menu</b>								
<b>[dir]</b> [dir]	<i>Digital Input / Output (5 to 6)</i> <b>Direction</b> Set this function to operate as an input or output.	<b>OUT</b> Output (68) <b>IDCON</b> Input Dry Contact (44) <b>IN</b> Input Voltage (193)	Output	<b>Instance 1</b> <i>Map 1</i> <i>Map 2</i> 1000 1120  Offset to next instance ( <i>Map 1 &amp; Map 2</i> ) equals +30	0x6A (106) 5 to 6 1	82	6001	uint RWES
<b>[Fn]</b> [Fn]	<i>Digital Output (5 to 6)</i> <b>Action Function</b> Select what function will drive this output.	<b>OFF</b> Off (62) <b>LIMIT</b> Limit (126) <b>ENTB</b> Profile Event Out B (234) <b>ENTA</b> Profile Event Out A (233) <b>SOF2</b> Special Function Output 2 (1533) <b>SOF1</b> Special Function Output 1 (1532) <b>COOL</b> Cool Power, Control Loop (161) <b>HEAT</b> Heat Power, Control Loop (160) <b>ALARM</b> Alarm (6)	Off	<b>Instance 1</b> <i>Map 1</i> <i>Map 2</i> 1008 1128  Offset to next instance ( <i>Map 1 &amp; Map 2</i> ) equals +30	0x6A (106) 1 to 2 5	83	6005	uint RWES
<b>Note:</b> Some values will be rounded off to fit in the four-character display. Full values can be read with other interfaces.  * Available with PM4, PM8 and PM9 models only								<b>R:</b> Read <b>W:</b> Write <b>E:</b> EE-PROM <b>S:</b> User Set

\* Pressure Altitude calculation is based on the International Standard Atmosphere, 1976

Setup Page

Display	Parameter Name Description	Range	Default	Modbus Relative Address	CIP Class Instance Attribute hex (dec)	Pro-fibus Index	Parameter ID	Data Type & Read/Write
<b>F i</b> [ Fi]	<i>Digital Output (5 to 6)</i> <b>Function Instance</b> Set the instance of the function selected above.	1 to 4	1	<b>Instance 1</b> <i>Map 1 Map 2</i> 1010 1130  Offset to next instance ( <i>Map 1 &amp; Map 2</i> ) equals +30	0x6A (106) 5 to 6 6	84	6006	uint RWES
<b>o.t.t</b> [ o.Ct]	<i>Digital Output (5 to 6)</i> <b>Control</b> Set the output control type. This parameter is only used with PID control, but can be set anytime.	<b>F.t.t</b> Fixed Time Base (34) <b>o.t.t</b> Variable Time Base (103)	Fixed Time Base	<b>Instance 1</b> <i>Map 1 Map 2</i> 1002 1122  Offset to next instance ( <i>Map 1 &amp; Map 2</i> ) equals +30	0x6A (106) 5 to 6 2	85	6002	uint RWES
<b>o.t.b</b> [ o.tb]	<i>Digital Output (5 to 6)</i> <b>Time Base</b> Set the time base for fixed-time-base control.	[ 0.1 for Fast and Bi-Directional outputs, 5.0 for Slow outputs] to 60	---	<b>Instance 1</b> <i>Map 1 Map 2</i> 1016 1124  Offset to next instance ( <i>Map 1 &amp; Map 2</i> ) equals +30	0x6A (106) 5 to 6 3	86	6003	float RWES
<b>o.l.o</b> [ o.Lo]	<i>Digital Output (5 to 6)</i> <b>Low Power Scale</b> The power output will never be less than the value specified and will represent the value at which output scaling begins.	0.0 to 100.0	0.0	<b>Instance 1</b> <i>Map 1 Map 2</i> 1016 1136  Offset to next instance ( <i>Map 1 &amp; Map 2</i> ) equals +30	0x6A (106) 5 to 6 9	87	6009	float RWES
<b>o.h i</b> [ o.hi]	<i>Digital Output (5 to 6)</i> <b>High Power Scale</b> The power output will never be greater than the value specified and will represent the value at which output scaling stops.	0.0 to 100.0	100.0	<b>Instance 1</b> <i>Map 1 Map 2</i> 1018 1138  Offset to next instance ( <i>Map 1 &amp; Map 2</i> ) equals +30	0x6A (106) 5 to 6 0xA (10)	88	6010	float RWES
<b>Note:</b> Some values will be rounded off to fit in the four-character display. Full values can be read with other interfaces.  * Available with PM4, PM8 and PM9 models only								<b>R:</b> Read <b>W:</b> Write <b>E:</b> EE-PROM <b>S:</b> User Set

Setup Page

Display	Parameter Name Description	Range	Default	Modbus Relative Address	CIP Class Instance Attribute hex (dec)	Pro-fibus Index	Parameter ID	Data Type & Read/Write
<input type="checkbox"/> <b>LEv</b> [ LEv]	<b>Digital Input (5 to 6) Level</b> Select which action will be interpreted as a true state.	<b>h,9h</b> High (37) <b>LoLuJ</b> Low (53)	High	<b>Instance 1</b> <i>Map 1</i> <i>Map 2</i> 1320 1560  Offset to next instance ( <i>Map 1</i> & <i>Map 2</i> ) equals +20	0x6E (110) 5 to 6 1	137	10001	uint RW
<input type="checkbox"/> <b>Fn</b> [ Fn]	<b>Digital Input (5 to 6) Action Function</b> Select the function that will be triggered by a true state for Digital Input 5 and or 6.	<b>nonE</b> None (61) <b>SSeP</b> Profile Start Step (1077) <b>PSEs</b> Profile Start/Stop, level triggered (208) <b>ProF</b> Profile Start Number, edge triggered (196) <b>PhoL</b> Profile Hold/Resume, level triggered (207) <b>Pd iS</b> Profile Disable, level triggered (206) <b>EdR</b> TRU-TUNE+® Disable, level triggered (219) <b>oFF</b> Control Outputs Off, level triggered (90) <b>ManA</b> Manual/Auto Mode, level triggered (54) <b>EUne</b> Tune, edge triggered (98) <b>idLE</b> Idle Set Point Enable, level triggered (107) <b>FAL</b> Force Alarm, level triggered (218) <b>RoF</b> Alarm Outputs & Control Loop Off, level triggered (220) <b>S iL</b> Silence Alarms, edge triggered (108) <b>ALRn</b> Alarm Reset, edge triggered (6) <b>PLoL</b> Lock Keypad, level triggered (217) <b>uSrr</b> Restore User Settings, edge triggered (227) <b>LRn</b> Limit Reset, edge triggered (82)	None	<b>Instance 1</b> <i>Map 1</i> <i>Map 2</i> 1324 1564  Offset to next instance ( <i>Map 1</i> & <i>Map 2</i> ) equals +20	0x6E (110) 1 to 2 3	138	10003	uint RWES
<b>Note:</b> Some values will be rounded off to fit in the four-character display. Full values can be read with other interfaces.  * Available with PM4, PM8 and PM9 models only								R: Read W: Write E: EE-PROM S: User Set

Setup Page

Display	Parameter Name Description	Range	Default	Modbus Relative Address	CIP Class Instance Attribute hex (dec)	Pro-fibus Index	Parameter ID	Data Type & Read/Write
<input type="checkbox"/> <b>F</b> [ Fi]	<i>Digital Input (5 to 7)</i> <b>Function Instance</b> Select which Digital Input will be triggered by a true state.	0 to 4	0	<b>Instance 1</b> <i>Map 1</i> <i>Map 2</i> 1326 1566  Offset to next instance ( <i>Map 1 &amp; Map 2</i> ) equals +20	0x6E (110) 5 to 7 4	139	10004	uint RWES
<b>Loop Set</b> <b>Control Loop Menu</b>								
<input type="checkbox"/> <b>hAg</b> [ h.Ag]	<i>Control Loop (1)</i> <b>Heat Algorithm</b> Set the heat control method.	<input type="checkbox"/> <b>OFF</b> Off (62) <input type="checkbox"/> <b>Pid</b> PID (71) <input type="checkbox"/> <b>onoff</b> On-Off (64)	PID	<b>Instance 1</b> <i>Map 1</i> <i>Map 2</i> 1884 2364	0x97 (151) 1 3	72	8003	uint RWES
<input type="checkbox"/> <b>CAG</b> [ C.Ag]	<i>Control Loop (1)</i> <b>Cool Algorithm</b> Set the cool control method.	<input type="checkbox"/> <b>OFF</b> Off (62) <input type="checkbox"/> <b>Pid</b> PID (71) <input type="checkbox"/> <b>onoff</b> On-Off (64)	Off	<b>Instance 1</b> <i>Map 1</i> <i>Map 2</i> 1886 2366	0x97 (151) 1 4	73	8004	uint RWES
<input type="checkbox"/> <b>CCr</b> [ C.Cr]	<i>Control Loop (1)</i> <b>Cool Output Curve</b> Select a cool output curve to change the responsiveness of the system.	<input type="checkbox"/> <b>OFF</b> Off (62) <input type="checkbox"/> <b>CrA</b> Non-linear Curve 1 (214) <input type="checkbox"/> <b>CrB</b> Non-linear Curve 2 (215)	Off	<b>Instance 1</b> <i>Map 1</i> <i>Map 2</i> 1888 2368	0x97 (151) 1 5	----	8038	uint RWES
<input type="checkbox"/> <b>tUn</b> [ t.tUn]	<i>Control Loop (1)</i> <b>TRU-TUNE+™ Enable</b> Enable or disable the TRU-TUNE+™ adaptive tuning feature.	<input type="checkbox"/> <b>no</b> No (59) <input type="checkbox"/> <b>YES</b> Yes (106)	No	<b>Instance 1</b> <i>Map 1</i> <i>Map 2</i> 1910 2390	0x97 (151) 1 0x10 (16)	----	8022	uint RWES
<input type="checkbox"/> <b>t.bnd</b> [ t.bnd]	<i>Control Loop (1)</i> <b>TRU-TUNE+™ Band</b> Set the range, centered on the set point, within which TRU-TUNE+™ will be in effect. Use this function only if the controller is unable to adaptive tune automatically.	0 to 100	0	<b>Instance 1</b> <i>Map 1</i> <i>Map 2</i> 1912 2392	0x97 (151) 1 0x11 (17)	----	8034	uint RWES
<input type="checkbox"/> <b>t.gn</b> [ t.gn]	<i>Control Loop (1)</i> <b>TRU-TUNE+™ Gain</b> Select the responsiveness of the TRU-TUNE+™ adaptive tuning calculations. More responsiveness may increase overshoot.	1 to 6	3	<b>Instance 1</b> <i>Map 1</i> <i>Map 2</i> 1914 2394	0x97 (151) 1 0x12 (18)	----	8035	uint RWES
<input type="checkbox"/> <b>t.Agr</b> [ t.Agr]	<i>Control Loop (1)</i> <b>Autotune Aggressiveness</b> Select the aggressiveness of the autotuning calculations.	<input type="checkbox"/> <b>Undr</b> Under damped (99) <input type="checkbox"/> <b>CrIt</b> Critical damped (21) <input type="checkbox"/> <b>Over</b> Over damped (69)	Critical	<b>Instance 1</b> <i>Map 1</i> <i>Map 2</i> 1916 2396	0x97 (151) 1 0x13 (19)	----	8024	uint RWES
<b>Note:</b> Some values will be rounded off to fit in the four-character display. Full values can be read with other interfaces.  * Available with PM4, PM8 and PM9 models only								R: Read W: Write E: EE-PROM S: User Set

Setup Page

Display	Parameter Name Description	Range	Default	Modbus Relative Address	CIP Class Instance Attribute hex (dec)	Pro-fibus Index	Parameter ID	Data Type & Read/Write
<b>[P.dL]</b> [P.dL]	<i>Control Loop (1)</i> <b>Peltier Delay</b> Set a value that will cause a delay when switching from heat mode to cool mode.	0.0 to 5.0	0.0	<b>Instance 1</b> <i>Map 1</i> <i>Map 2</i> -----	0x97 (151) 1 0x1C (28)	----	8051	float RWES
<b>[UFA]</b> [UFA]	<i>Control Loop (1)</i> <b>User Failure Action</b> Select what the controller outputs will do when the user switches control to manual mode.	<b>[OFF]</b> Off, sets output power to 0% (62) <b>[BPLS]</b> Bumpless, maintains same output power, if it was less than 75% and stable, otherwise 0% (14) <b>[MAN]</b> Manual Fixed, sets output power to Manual Power setting (33) <b>[USER]</b> User, sets output power to last open-loop set point the user entered (100)	User	<b>Instance 1</b> <i>Map 1</i> <i>Map 2</i> 2182   2662	0x6B (107) 1 0xC (12)	----	7012	uint RWES
<b>[FAiL]</b> [FAiL]	<i>Control Loop (1)</i> <b>Input Error Failure</b> Select what the controller outputs will do when an input error switches control to manual mode.	<b>[OFF]</b> Off, sets output power to 0% (62) <b>[BPLS]</b> Bumpless, maintains same output power, if it was less than 75% and stable, otherwise 0% (14) <b>[MAN]</b> Manual Fixed, sets output power to Manual Power setting (33) <b>[USER]</b> User, sets output power to last open-loop set point the user entered (100)	User	<b>Instance 1</b> <i>Map 1</i> <i>Map 2</i> 2184   2664	0x6B (107) 1 0xD (13)	----	7013	uint RWES
<b>[MAN]</b> [MAN]	<i>Control Loop (1)</i> <b>Manual Power</b> Set the manual output power level that will take effect if an input error failure occurs while User Failure Action is set to Manual Fixed.	Set Point Open Loop Limit Low to Set Point Open Loop Limit High (Setup Page)	0.0	<b>Instance 1</b> <i>Map 1</i> <i>Map 2</i> 2180   2660	0x6B (107) 1 0xB (11)	----	7011	float RWES
<b>[L.dE]</b> [L.dE]	<i>Control Loop (1)</i> <b>Open Loop Detect Enable</b> Turn on the open-loop detect feature to monitor a closed-loop operation for the appropriate response.	<b>[no]</b> No (59) <b>[YES]</b> Yes (106)	No	<b>Instance 1</b> <i>Map 1</i> <i>Map 2</i> 1922   2402	0x97 (151) 1 0x16 (22)	74	8039	uint RWES
<b>[L.dt]</b> [L.dt]	<i>Control Loop (1)</i> <b>Open Loop Detect Time</b> The Open Loop Detect Deviation value must occur for this time period to trigger an open-loop error.	0 to 3,600 seconds	240	<b>Instance 1</b> <i>Map 1</i> <i>Map 2</i> 1924   2404	0x97 (151) 1 0x17 (23)	75	8040	uint RWES
<p><b>Note:</b> Some values will be rounded off to fit in the four-character display. Full values can be read with other interfaces.</p> <p>* Available with PM4, PM8 and PM9 models only</p>								
								R: Read W: Write E: EE-PROM S: User Set



Setup Page

Display	Parameter Name Description	Range	Default	Modbus Relative Address	CIP Class Instance Attribute hex (dec)	Pro-fibus Index	Parameter ID	Data Type & Read/Write
<u>Ldd</u> [ L.dd]	<i>Control Loop (1)</i> <b>Open Loop Detect Deviation</b> Set the value that the process must deviate from the set point to trigger an open-loop error.	-1,999.000 to 9,999.000°F or units -1,110.555 to 5,555.000°C	10.0°F or units 6.0°C	<b>Instance 1</b> Map 1 Map 2 1926 2406	0x97 (151) 1 0x18 (24)	76	8041	float RWES
<u>rP</u> [ rP]	<i>Control Loop (1)</i> <b>Ramp Action</b> Select when the controller's set point will ramp to the defined end set point.	<u>oFF</u> Off (62) <u>StR</u> Startup (88) <u>StPt</u> Set Point Change (1647) <u>both</u> Both (13)	Off	<b>Instance 1</b> Map 1 Map 2 2186 2666	0x6B (107) 1 0xE (14)	56	7014	uint RWES
<u>rSC</u> [ r.SC]	<i>Control Loop (1)</i> <b>Ramp Scale</b> Select the scale of the ramp rate.	<u>hOUr</u> Hours (39) <u>Min</u> Minutes (57)	Minutes	<b>Instance 1</b> Map 1 Map 2 2188 2668	0x6B (107) 1 0xF (15)	57	7015	uint RWES
<u>rRt</u> [ r.rt]	<i>Control Loop (1)</i> <b>Ramp Rate</b> Set the rate for the set point ramp. Set the time units for the rate with the Ramp Scale parameter.	0.0 to 9,999.000°F or units 0.0 to 5,555.000°C	1.0°F or units 1.0°C	<b>Instance 1</b> Map 1 Map 2 2192 2672	0x6B (107) 1 0x11 (17)	58	7017	float RWES
<u>LSP</u> [ L.SP]	<i>Control Loop (1)</i> <b>Low Set Point</b> Set the minimum value of the closed loop set point range.	-1,999.000 to 9,999.000°F or units -1,128.000 to 5,537.000°C	-1,999°F or units -1,128°C	<b>Instance 1</b> Map 1 Map 2 2164 2644	0x6B (107) 1 to 2 3	52	7003	float RWES
<u>hSP</u> [ h.SP]	<i>Control Loop (1)</i> <b>High Set Point</b> Set the maximum value of the closed loop set point range..	-1,999.000 to 9,999.000°F or units -1,128.000 to 5,537.000°C	-1,999°F or units -1,128°C	<b>Instance 1</b> Map 1 Map 2 2166 2646	0x6B (107) 1 4	53	7004	float RWES
<u>SPLo</u> [SP.Lo]	<i>Control Loop (1)</i> <b>Set Point Open Limit Low</b> Set the minimum value of the open-loop set point range.	-100 to 100%	-100	<b>Instance 1</b> Map 1 Map 2 2168 2649	0x6B (107) 1 5	54	7005	float RWES
<u>SPhi</u> [SP.hi]	<i>Control Loop (1)</i> <b>Set Point Open Limit High</b> Set the maximum value of the open-loop set point range.	-100 to 100%	100	<b>Instance 1</b> Map 1 Map 2 2170 2650	0x6B (107) 1 6	55	7006	float RWES
<p><b>Note:</b> Some values will be rounded off to fit in the four-character display. Full values can be read with other interfaces.</p> <p>* Available with PM4, PM8 and PM9 models only</p>								R: Read W: Write E: EE-PROM S: User Set

Setup Page

Display	Parameter Name Description	Range	Default	Modbus Relative Address	CIP Class Instance Attribute hex (dec)	Pro-fibus Index	Parameter ID	Data Type & Read/Write
<b>o t P t</b> <b>S E t</b> <b>Output Menu</b>								
<b>Fn</b> [ Fn]	<i>Output Digital (1 to 2)</i> <b>Function</b> Select what function will drive this output.	<b>oFF</b> Off (62) <b>Entb</b> Profile Event Out B (234) <b>EntA</b> Profile Event Out A (233) <b>CoOL</b> Cool (20) <b>HEAT</b> Heat (36) <b>ALRT</b> Alarm (6)	Output 1 - Heat Output 2 - Alarm Output 3 - Off Output 4 - Off	<b>Instance 1</b> <i>Map 1 Map 2</i> 888 1008  Offset to next instance ( <i>Map 1 &amp; Map 2</i> ) equals +30	0x6A (106) 1 to 2 5	83	6005	uint RWES
<b>Fi</b> [ Fi]	<i>Output Digital (1 to 2)</i> <b>Function Instance</b> Set the instance of the function selected above.	1 to 2	1	<b>Instance 1</b> <i>Map 1 Map 2</i> 890 1010  Offset to next instance ( <i>Map 1 &amp; Map 2</i> ) equals +30	0x6A (106) 1 to 2 6	84	6006	uint RWES
<b>oCt</b> [ o.Ct]	<i>Output Digital (1 to 2)</i> <b>Control</b> Set the output control type. This parameter is only used with PID control, but can be set anytime.	<b>FTb</b> Fixed Time Base (34) <b>uTb</b> Variable Time Base (103)	Fixed Time Base	<b>Instance 1</b> <i>Map 1 Map 2</i> 882 1002  Offset to next instance ( <i>Map 1 &amp; Map 2</i> ) equals +30	0x6A (106) 1 to 4 2	85	6002	uint RWES
<b>oTb</b> [ o.tb]	<i>Output Digital (1 to 2)</i> <b>Time Base</b> Set the time base for fixed-time-base control.	0.1 to 60.0 seconds (solid-state relay or switched dc) 5.0 to 60.0 seconds (mechanical relay or no-arc power control)	0.1 sec. [SSR & sw dc] 20.0 sec. [mech, relay, no-arc]	<b>Instance 1</b> <i>Map 1 Map 2</i> 884 1004  Offset to next instance ( <i>Map 1 &amp; Map 2</i> ) equals +30	0x6A (106) 1 to 2 3	86	6003	float RWES
<b>oLo</b> [ o.Lo]	<i>Output Digital (1 to 2)</i> <b>Low Power Scale</b> The power output will never be less than the value specified and will represent the value at which output scaling begins.	0.0 to 100.0%	0.0%	<b>Instance 1</b> <i>Map 1 Map 2</i> 896 1016  Offset to next instance ( <i>Map 1 &amp; Map 2</i> ) equals +30	0x6A (106) 1 to 2 9	87	6009	float RWES
<b>Note:</b> Some values will be rounded off to fit in the four-character display. Full values can be read with other interfaces.  * Available with PM4, PM8 and PM9 models only								R: Read W: Write E: EE-PROM S: User Set

Setup Page

Display	Parameter Name Description	Range	Default	Modbus Relative Address	CIP Class Instance Attribute hex (dec)	Pro-fibus Index	Parameter ID	Data Type & Read/Write
<b>o.h.</b> [ o.hi]	<b>Output Digital (1 to 2)</b> <b>High Power Scale</b> The power output will never be greater than the value specified and will represent the value at which output scaling stops.	0.0 to 100.0%	100.0%	<b>Instance 1</b> Map 1 Map 2 898 1018  Offset to next instance (Map 1 & Map 2) equals +30	0x6A (106) 1 to 2 0xA (10)	88	6010	float RWES
<b>o.t.y</b> [ o.ty]	<b>Output Digital (1)</b> <b>Type</b> Select whether the process output will operate in volts or milliamps.	<b>v.o.l.t</b> Volts (104) <b>m.i.l.l.i.a.m.p.s</b> Milliamps (112)	Volts	<b>Instance 1</b> Map 1 Map 2 720 840	0x76 (118) 1 1	95	18001	uint RWES
<b>F.n</b> [ Fn]	<b>Output Process (1)</b> <b>Function</b> Set the type of function that will drive this output.	<b>o.f.f</b> Off (62) <b>d.u.p.l</b> Duplex (212) <b>c.o.o.l</b> Cool (20) <b>h.e.a.t</b> Heat (36) <b>r.e.t.r.a.n.s.m.i.t</b> Retransmit (213) <b>e.n.t.b</b> Profile Event Out B (234) <b>e.n.t.a</b> Profile Event Out A (233) <b>a.l.a.r.m</b> Alarm (6)	Off	<b>Instance 1</b> Map 1 Map 2 722 842	0x76 (118) 1 2	96	18002	uint RWES
<b>r.Sr</b> [ r.Sr]	<b>Output Process (1)</b> <b>Retransmit Source</b> Select the value that will be retransmitted.	<b>a.i</b> Analog Input (142) <b>s.e.t.p.o.i.n.t</b> Set Point (85) <b>c.u.r.r</b> Current (22)	Analog Input	<b>Instance 1</b> Map 1 Map 2 724 844	0x76 (118) 1 3	97	18003	uint RWES
<b>F.i</b> [ Fi]	<b>Output Process (1)</b> <b>Function Instance</b> Set the instance of the function selected above.	1 to 4	1	<b>Instance 1</b> Map 1 Map 2 726 846	0x76 (118) 1 4	98	18004	uint RWES
<b>S.Lo</b> [ S.Lo]	<b>Output Process (1)</b> <b>Scale Low</b> Set the minimum value of the output range.	-100.0 to 100.0	0.00	<b>Instance 1</b> Map 1 Map 2 736 856	0x76 (118) 1 9	99	18009	float RWES
<b>S.h.</b> [ S.hi]	<b>Output Process (1)</b> <b>Scale High</b> Set the maximum value of the output range.	-100.0 to 100.0	10.00	<b>Instance 1</b> Map 1 Map 2 738 858	0x76 (118) 1 0xA (10)	100	18010	float RWES
<b>r.Lo</b> [ r.Lo]	<b>Output Process (1)</b> <b>Range Low</b> Set the minimum value of the retransmit value range in process units. When the retransmit source is at this value, the retransmit output will be at its Scale Low value.	-1,999.000 to 9,999.000°F or units -1,128.000 to 5,537.000°C	0.0°F or units -18°C	<b>Instance 1</b> Map 1 Map 2 740 860	0x76 (118) 1 0xB (11)	101	18011	float RWES
<b>Note:</b> Some values will be rounded off to fit in the four-character display. Full values can be read with other interfaces.  * Available with PM4, PM8 and PM9 models only								R: Read W: Write E: EE-PROM S: User Set

Setup Page

Display	Parameter Name Description	Range	Default	Modbus Relative Address	CIP Class Instance Attribute hex (dec)	Pro-fibus Index	Parameter ID	Data Type & Read/Write
<input type="checkbox"/> r.h. [ r.hi]	<i>Output Process (1)</i> <b>Range High</b> Set the maximum value of the retransmit value range in process units. When the retransmit source is at this value, the retransmit output will be at its Scale High value.	-1,999.000 to 9,999.000°F or units -1,128.000 to 5,537.000°C	9,999.0°F or units 5,537.0°C	<b>Instance 1</b> Map 1    Map 2 742      862	0x76 (118) 1 0xC (12)	102	18012	float RWES
<input type="checkbox"/> o.L.o [ o.Lo]	<i>Output Process (1)</i> <b>Low Power Scale</b> The power output will never be less than the value specified and will represent the value at which power scaling begins.	0.0 to 100%	0.0%	<b>Instance 1</b> Map 1    Map 2 744      864	0x76 (118) 1 0x0D (13)	103	18013	float RWES
<input type="checkbox"/> o.h. [ o.hi]	<i>Output Process (1)</i> <b>High Power Scale</b> The power output will never be greater than the value specified and will represent the value at which power scaling stops.	0.0 to 100%	100%	<b>Instance 1</b> Map 1    Map 2 746      866	0x76 (118) 1 0x0E (14)	104	18014	float RWES
<input type="checkbox"/> o.C.A [ o.CA]	<i>Output Process (1)</i> <b>Calibration Offset</b> Set an offset value for a process output.	-1,999.000 to 9,999.000°F or units -1,110.555 to 5,555.000°C	0.0°F or units 0.0°C	<b>Instance 1</b> Map 1    Map 2 732      852	0x76 (118) 1 7	105	18007	float RWES
<b>ALARM</b> <b>SEE</b> <b>Alarm Menu</b>								
<input type="checkbox"/> R.E.Y [ A.ty]	<i>Alarm (1 to 4)</i> <b>Type</b> Select whether the alarm trigger is a fixed value or will track the set point.	<input type="checkbox"/> OFF Off (62) <input type="checkbox"/> Pr.AL Process Alarm (76) <input type="checkbox"/> DE.AL Deviation Alarm (24)	Off	<b>Instance 1</b> Map 1    Map 2 1508    1908	0x6D (109) 1 to 4 0xF (15)	20	9015	uint RWES
<input type="checkbox"/> S.r.A [ Sr.A]	<i>Alarm (1 to 4)</i> <b>Source Function A</b> Select what will trigger this alarm.	<input type="checkbox"/> A Analog Input (142) <input type="checkbox"/> P.L.U.r Power, Control Loop (73) <input type="checkbox"/> P.V Process Value (241) <input type="checkbox"/> L.n.r Linearization (238) <input type="checkbox"/> C.U.r.r Current (22)	If Alarm type is set to Deviation or Process.	<b>Instance 1</b> Map 1    Map 2 1512    1912	0x6D (109) 1 to 4 0x11 (17)	21	9017	uint RWES
<b>Note:</b> Some values will be rounded off to fit in the four-character display. Full values can be read with other interfaces.  * Available with PM4, PM8 and PM9 models only								
								R: Read W: Write E: EE- PROM S: User Set

Setup Page

Display	Parameter Name Description	Range	Default	Modbus Relative Address	CIP Class Instance Attribute hex (dec)	Pro- fibus Index	Param- eter ID	Data Type & Read/ Write
<u>RLH</u> [ A.hy]	<i>Alarm (1 to 4)</i> <b>Hysteresis</b> Set the hysteresis for an alarm. This determines how far into the safe region the process value needs to move before the alarm can be cleared.	0.001 to 9,999.000°F or units 0.001 to 5,555.000°C	1.0°F or units 1.0°C	<b>Instance 1</b> <i>Map 1</i> <i>Map 2</i> 1484 1884  Offset to next instance ( <i>Map</i> <i>1 equals +50,</i> <i>for Map 2</i> <i>equals +60</i> )	0x6D (109) 1 to 4 3	24	9003	float RWES
<u>RLG</u> [ A.Lg]	<i>Alarm (1 to 4)</i> <b>Logic</b> Select what the output condition will be during the alarm state.	<u>RLC</u> Close On Alarm (17) <u>RLA</u> Open On Alarm (66)	Close On Alarm	<b>Instance 1</b> <i>Map 1</i> <i>Map 2</i> 1488 1888  Offset to next instance ( <i>Map</i> <i>1 equals +50,</i> <i>for Map 2</i> <i>equals +60</i> )	0x6D (109) 1 to 4 5	25	9005	uint RWES
<u>RSd</u> [ A.Sd]	<i>Alarm (1 to 4)</i> <b>Sides</b> Select which side or sides will trigger this alarm.	<u>both</u> Both (13) <u>h,gh</u> High (37) <u>low</u> Low (53)	Both	<b>Instance 1</b> <i>Map 1</i> <i>Map 2</i> 1486 1886  Offset to next instance ( <i>Map</i> <i>1 equals +50,</i> <i>for Map 2</i> <i>equals +60</i> )	0x6D (109) 1 to 4 4	26	9004	uint RWES
<u>RLA</u> [ A.LA]	<i>Alarm (1 to 4)</i> <b>Latching</b> Turn alarm latching on or off. A latched alarm has to be turned off by the user.	<u>nLAL</u> Non-Latching (60) <u>LAL</u> Latching (49)	Non- Latching	<b>Instance 1</b> <i>Map 1</i> <i>Map 2</i> 1492 1892  Offset to next instance ( <i>Map</i> <i>1 equals +50,</i> <i>for Map 2</i> <i>equals +60</i> )	0x6D (109) 1 to 4 7	27	9007	uint RWES
<u>RLB</u> [ A.bL]	<i>Alarm (1 to 4)</i> <b>Blocking</b> Select when an alarm will be blocked. After startup and/or after the set point changes, the alarm will be blocked until the process value enters the normal range.	<u>OFF</u> Off (62) <u>STr</u> Startup (88) <u>SEPt</u> Set Point (85) <u>both</u> Both (13)	Off	<b>Instance 1</b> <i>Map 1</i> <i>Map 2</i> 1494 1894  Offset to next instance ( <i>Map</i> <i>1 equals +50,</i> <i>for Map 2</i> <i>equals +60</i> )	0x6D (109) 1 to 4 8	28	9008	uint RWES
<b>Note:</b> Some values will be rounded off to fit in the four-character display. Full values can be read with other interfaces.  * Available with PM4, PM8 and PM9 models only								R: Read W: Write E: EE- PROM S: User Set

Setup Page

Display	Parameter Name Description	Range	Default	Modbus Relative Address	CIP Class Instance Attribute hex (dec)	Pro-fibus Index	Parameter ID	Data Type & Read/Write
<b>RS</b> [A.Si]	<b>Alarm (1 to 4) Silencing</b> Turn alarm silencing on to allow the user to disable this alarm.	<b>oFF</b> Off (62) <b>on</b> On (63)	Off	<b>Instance 1</b> <i>Map 1</i> <i>Map 2</i> 1490 1890  Offset to next instance ( <i>Map 1 equals +50, for Map 2 equals +60</i> )	0x6D (109) 1 to 4 6	29	9006	uint RWES
<b>RdSP</b> [A.dSP]	<b>Alarm (1 to 4) Display</b> Display an alarm message when an alarm is active.	<b>oFF</b> Off (62) <b>on</b> On (63)	On	<b>Instance 1</b> <i>Map 1</i> <i>Map 2</i> 1510 1910  Offset to next instance ( <i>Map 1 equals +50, for Map 2 equals +60</i> )	0x6D (109) 1 to 4 0x10 (16)	30	9016	uint RWES
<b>RdL</b> [A.dL]	<b>Alarm (1 to 4) Delay</b> Set the span of time that the alarm will be delayed after the process value exceeds the alarm set point.	0 to 9,999 seconds	0	<b>Instance 1</b> <i>Map 1</i> <i>Map 2</i> 1520 1920  Offset to next instance ( <i>Map 1 equals +50, for Map 2 equals +60</i> )	0x6D (109) 1 to 4 0x15 (21)	31	9021	uint RWES
<b>FUn</b> <b>SE</b> <b>Function Key Menu</b>								
<b>LEu</b> [LEv]	<b>Function Key (1 to 2) Level</b> The Function Key will always power up in the low state.  Pressing the Function Key will toggle the selected action.	<b>h,9h</b> High (37) <b>LoUJ</b> Low (53)	High	<b>Instance 1</b> <i>Map 1</i> <i>Map 2</i> 1320 1560 <b>Instance 2</b> <i>Map 1</i> <i>Map 2</i> 1340 1580	0x6E (110) 1 to 2 1	137	10001	uint RWES
<b>Note:</b> Some values will be rounded off to fit in the four-character display. Full values can be read with other interfaces.  * Available with PM4, PM8 and PM9 models only								R: Read W: Write E: EE-PROM S: User Set

Setup Page

Display	Parameter Name Description	Range	Default	Modbus Relative Address	CIP Class Instance Attribute hex (dec)	Profibus Index	Parameter ID	Data Type & Read/Write
<input type="checkbox"/> <b>Fn</b> [ Fn]	<i>Function Key (1 to 2)</i> <b>Digital Input Function</b> Program the EZ Key to trigger an action. Functions respond to a level state change or an edge level change.	<input type="checkbox"/> <b>none</b> None (61) <input type="checkbox"/> <b>SStP</b> Profile Start Step (1077) <input type="checkbox"/> <b>PStS</b> Profile Start/Stop, level triggered (208) <input type="checkbox"/> <b>PrOf</b> Profile Start Number, edge triggered (196) <input type="checkbox"/> <b>PhoL</b> Profile Hold/Resume, level triggered (207) <input type="checkbox"/> <b>Pd,S</b> Profile Disable, level triggered (206) <input type="checkbox"/> <b>EdB</b> TRU-TUNE+® Disable, level triggered (219) <input type="checkbox"/> <b>oFF</b> Control Outputs Off, level triggered (90) <input type="checkbox"/> <b>MMA</b> Manual/Auto Mode, level triggered (54) <input type="checkbox"/> <b>TUNE</b> Tune, edge triggered (98) <input type="checkbox"/> <b>idLE</b> Idle Set Point Enable, level triggered (107) <input type="checkbox"/> <b>FAL</b> Force Alarm, level triggered (218) <input type="checkbox"/> <b>RoF</b> Alarm Outputs & Control Loop Off, level triggered (220) <input type="checkbox"/> <b>SIL</b> Silence Alarms, edge triggered (108) <input type="checkbox"/> <b>RLM</b> Alarm Reset, edge triggered (6) <input type="checkbox"/> <b>PLoC</b> Lock Keypad, level triggered (217) <input type="checkbox"/> <b>uScR</b> Restore User Settings, edge triggered (227)	None	<b>Instance 1</b> <i>Map 1 Map 2</i> 1324 1564 <b>Instance 2</b> <i>Map 1 Map 2</i> 1344 1584	0x6E (110) 1 to 2 3	138	10003	uint RWES
<input type="checkbox"/> <b>Fi</b> [ Fi]	<i>Function Key (1 to 2)</i> <b>Instance</b> Select which instance the EZ Key will affect. If only one instance is available, any selection will affect it.	0 to 4	0	<b>Instance 1</b> <i>Map 1 Map 2</i> 1326 1566 <b>Instance 2</b> <i>Map 1 Map 2</i> 1346 1586	0x96 (110) 1 to 2 4	139	10004	uint RWES
<input type="checkbox"/> <b>GLbL</b> <input type="checkbox"/> <b>SEt</b> <b>Global Menu</b>								
<input type="checkbox"/> <b>C_F</b> [ C_F]	<i>Global</i> <b>Display Units</b> Select which scale to use for temperature.	<input type="checkbox"/> <b>F</b> °F (30) <input type="checkbox"/> <b>C</b> °C (15)	°F	<b>Instance 1</b> <i>Map 1 Map 2</i> 1838 2308	0x67 (103) 1 5	110	3005	uint RWES
<input type="checkbox"/> <b>AC.LF</b> [AC.LF]	<i>Global</i> <b>AC Line Frequency</b> Set the frequency to the applied ac line power source.	<input type="checkbox"/> <b>50</b> 50 Hz (3) <input type="checkbox"/> <b>60</b> 60 Hz (4)	60 Hz	<b>Instance 1</b> <i>Map 1 Map 2</i> 886 1006	0x6A (106) 1 4	89	1034	uint RWES
<b>Note:</b> Some values will be rounded off to fit in the four-character display. Full values can be read with other interfaces.  * Available with PM4, PM8 and PM9 models only								R: Read W: Write E: EE-PROM S: User Set

Setup Page

Display	Parameter Name Description	Range	Default	Modbus Relative Address	CIP Class Instance Attribute hex (dec)	Profibus Index	Parameter ID	Data Type & Read/Write
<b>[R.tyP]</b> [R.tyP]	<i>Profile</i> <b>Ramping Type</b>	<b>[RAtE]</b> Rate (81) <b>[tI]</b> Time (143)	Time	<b>Instance 1</b> <i>Map 1</i> <i>Map 2</i> ---- 4414	0x7A (122) 1 26 (38)	----	22038	uint RWE
<b>[P.tyP]</b> [P.tyP]	<i>Profile</i> <b>Profile Type</b> Set the profile startup to be based on a set point or a process value.	<b>[SEtP]</b> Set Point (85) <b>[Pro]</b> Process (75)	Set Point	<b>Instance 1</b> <i>Map 1</i> <i>Map 2</i> 2534 4354	0x7A (122) 1 8	----	22008	uint RWE
<b>[gSE]</b> [gSE]	<i>Profile</i> <b>Guaranteed Soak Enable</b> Enables the guaranteed soak deviation function in profiles.	<b>[oFF]</b> Off (62) <b>[oN]</b> On (63)	Off	<b>Instance 1</b> <i>Map 1</i> <i>Map 2</i> 2530 4350	0x7A (122) 1 6	----	22006	uint RWE
<b>[gSd1]</b> [gSd1]	<i>Profile</i> <b>Guaranteed Soak Deviation 1</b> Set the value of the deviation band that will be used in all profile step types. The process value must enter the deviation band before the step can proceed.	0.0 to 9,999.000°F or units 0.0 to 5,555.000°C	10.0°F or units 6.0°C	<b>Instance 1</b> <i>Map 1</i> <i>Map 2</i> 2532 4352	0x7A (122) 1 7	----	22007	float RWE
<b>[Si.a]</b> [Si.a]	<i>Profile Event Input</i> <b>Source Instance A</b> Set the digital source for WE1..	5 to 6	5	<b>Instance 1</b> <i>Map 1</i> <i>Map 2</i> ---- 4390	0x7A (122) 1 0x1A (26)	----	22060	uint RWES
<b>[Si.b]</b> [Si.b]	<i>Profile Event Input</i> <b>Source Instance B</b> Set the digital source for WE2..	5 to 6	5	<b>Instance 1</b> <i>Map 1</i> <i>Map 2</i> ---- 4392	7A (122) 1 0x1B (27)	----	22061	uint RWES
<b>[Poti]</b> [Poti]	<i>Global Menu</i> <b>Power Out Time</b> If profile is running and power is lost, profile will resume where it left off provided time set has not expired prior to power restoration.	0 to 9999 seconds	0	<b>Instance 1</b> <i>Map 1</i> <i>Map 2</i> ---- 4484	7A (122) 1 0x49 (73)	----	22073	uint RWE
<b>[C.LEd]</b> [C.LEd]	<i>Global Menu</i> <b>Communications LED Action</b> Turns comms LED on or off for selected comms ports.	<b>[Con1]</b> Comm port 2 (1189) <b>[Con2]</b> Comm port 1 (1190) <b>[both]</b> Comm port 1 and 2 (13) <b>[oFF]</b> Off (62)	both	<b>Instance 1</b> <i>Map 1</i> <i>Map 2</i> 1856 2326	0x6A (103) 1 0x0E (14)	----	3014	uint RWES
<b>[Zone]</b> [Zone]	<i>Global Menu</i> <b>Zone</b> Turns Zone LED on or off based on selection.	<b>[oFF]</b> Off (62) <b>[oN]</b> On (63)	On	<b>Instance 1</b> <i>Map 1</i> <i>Map 2</i> ---- 2350	0x6A (103) 1 0x1A (26)	----	3026	uint RWES
<b>Note:</b> Some values will be rounded off to fit in the four-character display. Full values can be read with other interfaces.  * Available with PM4, PM8 and PM9 models only								R: Read W: Write E: EE-PROM S: User Set



Setup Page

Display	Parameter Name Description	Range	Default	Modbus Relative Address	CIP Class Instance Attribute hex (dec)	Pro-fibus Index	Parameter ID	Data Type & Read/Write
[Chan] [Chan]	<i>Global Menu</i> <b>Channel</b> Turns Channel LED on or off based on selection.	[OFF] Off (62) [ON] On (63)	On	<b>Instance 1</b> Map 1 Map 2 ---- 2352	0x6A (103) 1 0x1B (27)	----	3027	uint RWES
[dPrS] [dPrS]	<i>Global Menu</i> <b>Display Pairs</b> Defines the number of Display Pairs.	1 to 10	2	<b>Instance 1</b> Map 1 Map 2 ---- 2354	0x6A (103) 1 0x1C (28)	----	3028	uint RWES
[dti] [d.ti]	<i>Global Menu</i> <b>Display Time</b> Time delay in toggling between channel 1 and channel 2.	0 to 60	0	<b>Instance 1</b> Map 1 Map 2 ---- 2356	0x6A (103) 1 0x1D (29)	----	3029	uint RWES
[USrS] [USr.S]	<i>Global Menu</i> <b>User Settings Save</b> Save all of this controller's settings to the selected set.	[SEE1] User Set 1 (101) [SEE2] User Set 2 (102) [none] None (61)	None	<b>Instance 1</b> Map 1 Map 2 26 26	0x(101) 1 0xE (14)	118	1014	uint RWE
[USr.r] [USr.r]	<i>Global Menu</i> <b>User Restore Settings</b> Replace all of this controller's settings with another set.	[FACTY] Factory (31) [none] None (61) [SEE1] User Set 1 (101) [SEE2] User Set 2 (102)	None	<b>Instance 1</b> Map 1 Map 2 24 24	0x65 (101) 1 0xD (13)	117	1013	uint RWE
<b>[CoM]</b> <b>[SEE]</b> <b>Communications Menu</b>								
[PCoL] [PCoL]	<i>Communications 1</i> <b>Protocol</b> Set the protocol of this controller to the protocol that this network is using.	[Std] Standard Bus (1286) [Mod] Modbus RTU (1057)	Modbus	<b>Instance 1</b> Map 1 Map 2 2492 2972	0x96 (150) 1 7	----	17009	uint RWE
[Ad.S] [Ad.S]	<i>Communications 1</i> <b>Address Standard Bus</b> Set the network address of this controller. Each device on the network must have a unique address. The Zone Display on the front panel will display this number.	1 to 16	1	<b>Instance 1</b> Map 1 Map 2 2480 2960	0x96 (150) 1 1	----	17001	uint RWE
[Ad.M] [Ad.M]	<i>Communications (1)</i> <b>Address Modbus</b> Set the network address of this controller. Each device on the network must have a unique address.	1 to 247	1	<b>Instance 1</b> Map 1 Map 2 2482 2962	0x96 (150) 1 2	----	17007	uint RWE
[bAUd] [bAUd]	<i>Communications (1)</i> <b>Baud Rate Modbus</b> Set the speed of this controller's communications to match the speed of the serial network.	9,600 (188) 19,200 (189) 38,400 (190)	9,600	<b>Instance 1</b> Map 1 Map 2 2484 2964	0x96 (150) 1 3	----	17002	uint RWE
<b>Note:</b> Some values will be rounded off to fit in the four-character display. Full values can be read with other interfaces.  * Available with PM4, PM8 and PM9 models only								<b>R:</b> Read <b>W:</b> Write <b>E:</b> EE-PROM <b>S:</b> User Set

Setup Page

Display	Parameter Name Description	Range	Default	Modbus Relative Address	CIP Class Instance Attribute hex (dec)	Pro-fibus Index	Parameter ID	Data Type & Read/Write
<input type="checkbox"/> <b>PAR</b> [ PAR]	<i>Communications (1)</i> <b>Parity Modbus (1)</b> Set the parity of this controller to match the parity of the serial network.	<input type="checkbox"/> <b>none</b> None (61) <input type="checkbox"/> <b>Even</b> Even (191) <input type="checkbox"/> <b>odd</b> Odd (192)	None	<b>Instance 1</b> <i>Map 1</i> <i>Map 2</i> 2486 2966	0x96 (150) 1 4	----	17003	uint RWE
<input type="checkbox"/> <b>C_F</b> [ C_F]	<i>Communications (1)</i> <b>Temperature Units</b> Select whether this communications channel will display in Celsius or Fahrenheit.  <b>Note:</b> Applies to Modbus only.	<input type="checkbox"/> <b>F</b> Fahrenheit (30) <input type="checkbox"/> <b>C</b> Celsius (15)	F	<b>Instance 1</b> <i>Map 1</i> <i>Map 2</i> 2490 2970	0x96 (150) 1 6	----	17050	uint RWE
<input type="checkbox"/> <b>M_hL</b> [M.hL]	<i>Communications (1)</i> <b>Modbus Word Order</b> Select the word order of the two 16-bit words in the floating-point values.	<input type="checkbox"/> <b>Loh</b> Low-High (1331) <input type="checkbox"/> <b>hLo</b> High-Low (1330)	Low-High	<b>Instance 1</b> <i>Map 1</i> <i>Map 2</i> 2488 2968	0x96 (150) 1 5	----	17043	uint RWE
<input type="checkbox"/> <b>MAP</b> [ Map]	<i>Communications (1)</i> <b>Data Map</b> If set to 1 the control will use PM legacy mapping. If set to 2 the control will use new mapping to accommodate new functions.	1 to 2	If 9th digit of part number is a 1, 2, 3 or D.	----	----	----	17059	----
<input type="checkbox"/> <b>nVS</b> [ nV.S]	<i>Communications (1)</i> <b>Non-volatile Save</b> If set to Yes all values written to the control will be saved in EEPROM.	<input type="checkbox"/> <b>YES</b> Yes (106) <input type="checkbox"/> <b>no</b> No (59)	Yes	<b>Instance 1</b> <i>Map 1</i> <i>Map 2</i> 2494 2974	0x96 (150) 1 8	198	17051	uint RWE
<input type="checkbox"/> <b>REL</b> * <input type="checkbox"/> <b>SEE</b> <b>Real Time Clock Menu</b>								
<input type="checkbox"/> <b>hour</b> [hoUr]	<i>Real Time Clock</i> <b>Hours</b>	0 to 23	0	<b>Instance 1</b> <i>Map 1</i> <i>Map 2</i> ---- 4004	88 (136) 1 3	----	36003	uint RW
<input type="checkbox"/> <b>Min</b> [Min]	<i>Real Time Clock</i> <b>Minutes</b>	0 to 59	0	<b>Instance 1</b> <i>Map 1</i> <i>Map 2</i> ---- 4006	88 (136) 1 4	----	36004	uint RW
<input type="checkbox"/> <b>doW</b> [doW]	<i>Real Time Clock</i> <b>Day of Week</b>	<input type="checkbox"/> <b>Sun</b> Sunday (1565) <input type="checkbox"/> <b>Mon</b> Monday (1559) <input type="checkbox"/> <b>Tue</b> Tuesday (1560) <input type="checkbox"/> <b>Wed</b> Wednesday (1561) <input type="checkbox"/> <b>Thu</b> Thursday (1562) <input type="checkbox"/> <b>Fri</b> Friday (1563) <input type="checkbox"/> <b>Sat</b> Saturday (1564)	Sun	<b>Instance 1</b> <i>Map 1</i> <i>Map 2</i> ---- 4002	88 (136) 1 2	----	36002	uint RW
<b>Note:</b> Some values will be rounded off to fit in the four-character display. Full values can be read with other interfaces.  * Available with PM4, PM8 and PM9 models only								<b>R:</b> Read <b>W:</b> Write <b>E:</b> EE-PROM <b>S:</b> User Set

# 7



## Chapter 7: Profiling Page









### Navigating the Profiling Page

**Note:**

Some of these menus and parameters may not appear, depending on the controller's options. See model number information in the Appendix for more information. If there is only one instance of a menu, no sub-menus will appear.

The Profiling Page allows you to enter your ramp and soak profile information.

To go to the Profiling Page from the Home Page, press the Advance Key  for three seconds, until **PROF** appears in the lower display and the profile number appears in the upper display. Press the Up  or Down  key to change to another profile.

- Press the Advance Key  to move to the selected profile's first step.
- Press the Up  or Down  keys to move through the steps.
- Press the Advance Key  to move through the selected step's settings.
- Press the Up  or Down  keys to change the step's settings.
- Press the Infinity Key  at any time to return to the step number prompt.
- Press the Infinity Key  again to return to the profile number prompt.
- From any point press and hold the Infinity Key  for two seconds to return to the Home Page.

**Note:**

Changes made to profile parameters in the Profiling Pages will be saved and will also have an immediate impact on the running profile. Some parameters in the Profile Status Menu can be changed for the currently running profile, but should only be changed by knowledgeable personnel and with caution. Changing parameters via the Profile Status Menu will not change the stored profile but will have an immediate impact on the profile that is running.

### Profiling Parameters

**PI** to **P4**

**PROF**

**1** to **10**

**PI**

**STEP** Step Type

**TSP1** Target Set Point Loop 1

**hOUR** Hours

**MIN** Minutes

**SEC** Seconds





**RATE** Rate

**WPT1** Wait For Process 1

**WET1** Wait For Event 1

### How to Start a Profile

After defining the profile follow the steps below to run the profile:

1. From the Home Page push the Advance Key  repeatedly until Profile Start **PST1** appears in the lower display.
2. Use the Up  or Down  key to choose the file or step number within a profile where you want the profile to begin running.
3. Press the Advance Key . This takes you to Profile Action **PAC1**, where you can select the appropriate action.
  - **none** No action
  - **PROF** Begin execution from first step of the specified profile number, whether it exists or not.
  - **PAUS** Pause the currently running profile.
  - **RESU** Resume running the profile from the previously paused step.
  - **End** End the profile.
  - **STEP** Begin running the profile from the specified step number.

**Note:**

Avoid continuous writes within loops. Excessive writes to EEPROM will cause premature EEPROM failure. The EEPROM is rated for 1,000,000 writes. (To disable EEPROM writes, go to the Setup Page and then the **CONF** menu. Proceed to the **WUS** prompt and set it to no for **CONF** 1, 2 or both.)

**WET2** Wait for Event 2

**DOBJ** Day of Week

**JS** Jump Step

**JC** Jump Count

**End** End Type

**ENT1** Event 1

**ENT2** Event 2

**Profiling Page**

Display	Parameter Name Description	Range	Default	Modbus Relative Address	CIP Class Instance Attribute hex (dec)	Parameter ID	Data Type & Read/Write
<div style="border: 1px solid black; background-color: #ffffcc; padding: 5px;"> <span style="border: 1px solid black; padding: 2px;">P1</span>  <span style="border: 1px solid black; padding: 2px;">Prof</span>  <b>Profiling Menu</b> </div>							
<span style="border: 1px solid black; padding: 2px;">P1</span> [ P1] to <span style="border: 1px solid black; padding: 2px;">P4</span> [ P4]	<b>Step</b> Select a step to edit or view.	1 to 10 [profile 1] 11 to 20 [profile 2] 21 to 30 [profile 3] 31 to 40 [profile 4]	----	----	----	----	----
<span style="border: 1px solid black; padding: 2px;">StYP</span> [S.typ]	<b>Step Type</b> Select a step type.  <b>Note:</b> When configuring the profile type there will be a Time prompt as delivered from the factory (default). If rate is desired navigate to the Setup Page and then the Global Menu where Ramping Type can be changed.	<span style="border: 1px solid black; padding: 2px;">USEP</span> Unused Step (50) <span style="border: 1px solid black; padding: 2px;">End</span> End (27) <span style="border: 1px solid black; padding: 2px;">JL</span> Jump Loop (116) <span style="border: 1px solid black; padding: 2px;">[L o C]</span> Wait For Time (1543) <span style="border: 1px solid black; padding: 2px;">[L o B o]</span> Wait For Both (210) <span style="border: 1px solid black; padding: 2px;">[L o P r]</span> Wait For Process (209) <span style="border: 1px solid black; padding: 2px;">[L o E]</span> Wait For Event (144) <span style="border: 1px solid black; padding: 2px;">SoRH</span> Soak (87) <span style="border: 1px solid black; padding: 2px;">[t ]</span> Time (143) <span style="border: 1px solid black; padding: 2px;">[r R E E]</span> Rate (81)	Unused	<b>Instance 1</b> Map 1    Map 2 2570    4500  Offset to next instance (Map 1 equals +50, Map 2 equals +100)	0x79 (121) 1 to 40 1	21001	uint RWE
<span style="border: 1px solid black; padding: 2px;">[t.SP1]</span>	<i>Step Type Parameters</i> <b>Target Set Point (loop 1)</b> Select the set point for this step.	-1,999.000 to 9,999.000°F or units -1,128 to 5,537.000°C	0.0°F or units -18°C	<b>Instance 1</b> Map 1    Map 2 2572    4502  Offset to next instance (Map 1 equals +50, Map 2 equals +100)	0x79 (121) 1 to 40 2	21002	float RWE
<span style="border: 1px solid black; padding: 2px;">[hoUr]</span>	<i>Step Type Parameters</i> <b>Hours</b> Select the hours (plus Minutes and Seconds) for a timed step.	0 to 99	0	<b>Instance 1</b> Map 1    Map 2 2574    4504  Offset to next instance (Map 1 equals +50, Map 2 equals +100)	0x79 (121) 1 to 40 3	21003	uint RWE
<span style="border: 1px solid black; padding: 2px;">[Min]</span>	<i>Step Type Parameters</i> <b>Minutes</b> Select the minutes (plus Hours and Seconds) for a timed step.	0 to 59	0	<b>Instance 1</b> Map 1    Map 2 2576    4506  Offset to next instance (Map 1 equals +50, Map 2 equals +100)	0x79 (121) 1 to 40 4	21004	uint RWE
<span style="border: 1px solid black; padding: 2px;">[SEC]</span>	<i>Step Type Parameters</i> <b>Seconds</b> Select the seconds (plus Hours and Minutes) for a timed step.	0 to 59	0	<b>Instance 1</b> Map 1    Map 2 2578    4508  Offset to next instance (Map 1 equals +50, Map 2 equals +100)	0x79 (121) 1 to 40 5	21005	uint RWE
<b>Note:</b> Some values will be rounded off to fit in the four-character display. Full values can be read with other interfaces.							R: Read W: Write E: EEPROM S: User Set

Profiling Page

Display	Parameter Name Description	Range	Default	Modbus Relative Address	CIP Class Instance Attribute hex (dec)	Parameter ID	Data Type & Read/Write
<b>rAtE</b> [rAtE]	<i>Step Type Parameters</i> <b>Rate</b> Select the rate for ramping in degrees or units per minute.	0 to 9,999.000°F or units per minute 0 to 5,555.000°C per minute	0.0	<b>Instance 1</b> <i>Map 1</i> <i>Map 2</i> 2580 4510  Offset to next instance ( <i>Map 1</i> equals +50, <i>Map 2</i> equals +100)	0x79 (121) 1 to 40 6	21006	float RWE
<b>W.P.1</b> [W.P.1]	<i>Step Type Parameters</i> <b>Wait For Process Value</b> Select which analog input Wait For Process will use.	-1,999.000 to 9,999.000°F or units -1,128.000 to 5,537.000°C	0.0°F or units -18.0°C	<b>Instance 1</b> <i>Map 1</i> <i>Map 2</i> 2590 4520  Offset to next instance ( <i>Map 1</i> equals +50, <i>Map 2</i> equals +100)	0x79 (121) 1 to 40 0xB (11)	21011	float RWE
<b>WE.1</b> [WE.1]	<i>Step Type Parameters</i> <b>Wait Event (5-6)</b> Select the event state that must be satisfied during this step. Digital input 5 provides the state of Event 1, and digital input 6 provides the state of Event 2.	<input type="checkbox"/> <b>OFF</b> Off (62) <input type="checkbox"/> <b>on</b> On (63) <input type="checkbox"/> <b>none</b> None (61)	Off	<b>Instance 1</b> <i>Map 1</i> <i>Map 2</i> 2586 4516  Offset to next instance ( <i>Map 1</i> equals +50, <i>Map 2</i> equals +100)	0x79 (121) 1 to 40 9	21009	uint RWE
<b>WE.2</b> [WE.2]	<i>Step Type Parameters</i> <b>Wait Event (5-6)</b> Select the event state that must be satisfied during this step. Digital input 5 provides the state of Event 1, and digital input 6 provides the state of Event 2.	<input type="checkbox"/> <b>OFF</b> Off (62) <input type="checkbox"/> <b>on</b> On (63) <input type="checkbox"/> <b>none</b> None (61)	Off	<b>Instance 1</b> <i>Map 1</i> <i>Map 2</i> 2588 4518  Offset to next instance ( <i>Map 1</i> equals +50, <i>Map 2</i> equals +100)	0x79 (121) 1 to 40 0xA (10)	21010	uint RWE
<b>dow</b> [dow]	<i>Step Type Parameters</i> <b>Day of Week</b>	<input type="checkbox"/> <b>Ed</b> Every Day (1567) <input type="checkbox"/> <b>Udd</b> Week days (1566) <input type="checkbox"/> <b>Sun</b> Sunday (1565) <input type="checkbox"/> <b>nnon</b> Monday (1559) <input type="checkbox"/> <b>tuE</b> Tuesday (1560) <input type="checkbox"/> <b>UJEd</b> Wednesday (1561) <input type="checkbox"/> <b>thUr</b> Thursday (1562) <input type="checkbox"/> <b>Fr,</b> Friday (1563) <input type="checkbox"/> <b>SAt</b> Saturday (1564)	Sunday	<b>Instance 1</b> <i>Map 1</i> <i>Map 2</i> ---- 4580  Offset to next instance <i>Map 2</i> equals +100)	0x79 (121) 1 to 40 0x29 (41)	21041	uint RWE
<b>JS</b> [ JS]	<i>Step Type Parameters</i> <b>Jump Step</b> Select a step to jump to.	1 to 40	0	<b>Instance 1</b> <i>Map 1</i> <i>Map 2</i> 2592 4522  Offset to next instance ( <i>Map 1</i> equals +50, <i>Map 2</i> equals +100)	0x79 (121) 1 to 40 0xC (12)	21012	uint RWE
<b>Note:</b> Some values will be rounded off to fit in the four-character display. Full values can be read with other interfaces.							<b>R:</b> Read <b>W:</b> Write <b>E:</b> EEPROM <b>S:</b> User Set



Profiling Page





Display	Parameter Name Description	Range	Default	Modbus Relative Ad- dress	CIP Class Instance Attribute hex (dec)	Param- eter ID	Data Type & Read/ Write
<input type="checkbox"/> <b>JC</b> [ JC]	<i>Step Type Parameters</i> <b>Jump Count</b> Set the number of jumps. A value of 0 creates an infinite loop. Loops can be nested four deep.	0 to 9,999	0	<b>Instance 1</b> <i>Map 1</i> <i>Map 2</i> 2594      4524  Offset to next instance ( <i>Map 1 equals +50, Map 2 equals +100</i> )	0x79 (121) 1 to 40 0xD (13)	21013	uint RWE
<input type="checkbox"/> <b>End</b> [ End]	<i>Step Type Parameters</i> <b>End Type</b> Select what the controller will do when this profile ends.	<input type="checkbox"/> <b>OFF</b> Control Mode set to Off (62) <input type="checkbox"/> <b>Hold</b> Hold last closed-loop set point in the profile (47) <input type="checkbox"/> <b>User</b> User, reverts to previous set point (100)	Off	<b>Instance 1</b> <i>Map 1</i> <i>Map 2</i> 2596      4526  Offset to next instance ( <i>Map 1 equals +50, Map 2 equals +100</i> )	0x79 (121) 1 to 40 0xE (14)	21014	uint RWE
<input type="checkbox"/> <b>Ent1</b> [Ent1]	<i>Step Type Parameters</i> <b>Profile Event Output (A)</b> Select whether Event Output 1 or 2 is on or off during this step.	<input type="checkbox"/> <b>OFF</b> Off (62) <input type="checkbox"/> <b>on</b> On (63)	Off	<b>Instance 1</b> <i>Map 1</i> <i>Map 2</i> 2582      4512  Offset to next instance ( <i>Map 1 equals +50, Map 2 equals +100</i> )	0x79 (121) 1 to 40 7	21007	uint RWE
<input type="checkbox"/> <b>Ent2</b> [Ent2]	<i>Step Type Parameters</i> <b>Profile Event Output (B)</b> Select whether Event Output 1 or 2 is on or off during this step.	<input type="checkbox"/> <b>OFF</b> Off (62) <input type="checkbox"/> <b>on</b> On (63)	Off	<b>Instance 1</b> <i>Map 1</i> <i>Map 2</i> 2584      4514  Offset to next instance ( <i>Map 1 equals +50, Map 2 equals +100</i> )	0x79 (121) 1 to 40 8	21008	uint RWE
<b>Note:</b> Some values will be rounded off to fit in the four-character display. Full values can be read with other interfaces.							<b>R:</b> Read <b>W:</b> Write <b>E:</b> EEPROM <b>S:</b> User Set





# 8

## Chapter 8: Factory Page

### Navigating the Factory Page

To go to the Factory Page from the Home Page, press and hold both the Advance  and Infinity  keys for six seconds.

- Press the Advance Key  to enter the menu of choice.
- If a submenu exists (more than one instance), press the Up  or Down  key to select and then press the Advance Key  to enter.

- Press the Up  or Down  key to move through available menu prompts.
- Press the Infinity Key  to move backwards through the levels: parameter to submenu; submenu to menu; menu to Home Page.
- Press and hold the Infinity Key  for two seconds to return to the Home Page.

#### Note:

Some of these menus and parameters may not appear, depending on the controller's options. See model number information in the Appendix for more information. If there is only one instance of a menu, no sub-menus will appear.

**[CUSE]**  
**[FCT4]** Custom Setup Menu  
 [ ] 1 to [ ] 20  
**[CUSE]** Custom Setup  
**[PRP]** Parameter  
 [ ] , [ ] Instance ID

**[LoC]**  
**[FCT4]** Security Setting Menu  
**[LoC]** Security Setting  
**[LoCo]** Operations Page  
**[LoCP]** Profiling Page  
**[PRSE]** Password Enable  
**[rLoC]** Read Lock  
**[SLoC]** Write Security  
**[LoCL]** Locked Access Level  
**[roLL]** Rolling Password  
**[PRSu]** User Password  
**[PRSA]** Administrator Password

**[ULoC]**  
**[FCT4]** Security Setting Menu  
**[LoDE]** Public Key  
**[PRSS]** Password

**[d.A9]**  
**[FCT4]** Diagnostics Menu  
**[d.A9]** Diagnostics  
**[Pn]** Part Number  
**[rEu]** Software Revision  
**[SbLd]** Software Build Number  
**[Sn]** Serial Number  
**[dRtE]** Date of Manufacture

**[CAL]**  
**[FCT4]** Calibration Menu  
 [ ] 1 to [ ] 2  
**[CAL]** Calibration  
**[P7u]** Electrical Measurement

**[EL 1.0]** Electrical Input Offset  
**[EL 1.5]** Electrical Input Slope  
**[EL 0.0]** Electrical Output Offset  
**[EL 1.5]** Electrical Output Slope

Factory Page

Display	Parameter Name Description	Range	Default	Modbus Relative Address	CIP Class Instance Attribute hex (dec)	Profibus Index	Parameter ID	Data Type & Read/Write
<p><b>Custom Menu</b></p> <p><b>Custom Menu</b></p>								
<p><b>PAR</b> [Par]</p>	<p><i>Custom</i> <b>Parameter 1 to 20</b> Select the parameters that will appear in the Home Page.</p> <p>The Parameter 1 value will appear in the upper display of the Home Page. It cannot be changed with the Up and Down Keys in the Home Page.</p> <p>The Parameter 2 value will appear in the lower display in the Home Page. It can be changed with the Up and Down Keys, if the parameter is a writable one.</p> <p>Scroll through the other Home Page parameters with the Advance Key  .</p>	<p><b>none</b> None</p> <p><b>gsd1</b> Guaranteed Soak Deviation 1 Value</p> <p><b>PAR</b> Profile Action Request</p> <p><b>PSt</b> Profile Start</p> <p><b>idle</b> Idle Set Point</p> <p><b>ETUn</b> TRU-TUNE+® Enable</p> <p><b>rrt</b> Ramp Rate</p> <p><b>Chy</b> Cool Hysteresis</p> <p><b>CPb</b> Cool Proportional Band</p> <p><b>hhy</b> Heat Hysteresis</p> <p><b>hPb</b> Heat Proportional Band</p> <p><b>db</b> Dead Band</p> <p><b>td</b> Time Derivative</p> <p><b>ti</b> Time Integral</p> <p><b>CP</b> Cool Power</p> <p><b>hP</b> Heat Power</p> <p><b>CPM</b> User Control Mode</p> <p><b>AUT</b> Autotune</p> <p><b>oP</b> Open Loop Set Point</p> <p><b>ACSP</b> Active Set Point</p> <p><b>ACPv</b> Active Process Value</p> <p><b>SEPE</b> Set Point</p> <p><b>USE</b> Custom Menu</p> <p><b>Ahy</b> Alarm Hysteresis</p> <p><b>Ah</b> Alarm High Set Point</p> <p><b>ALo</b> Alarm Low Set Point</p> <p><b>USrr</b> User Restore Set</p> <p><b>C_F</b> Display Units</p> <p><b>iCR</b> Input Calibration Offset</p> <p><b>Pro</b> Process</p>	See: Home Page	----	----	----	14005	uint RWES
<p><b>iid</b> [iid]</p>	<p><i>Custom (1 to 20)</i> <b>Instance ID</b> Select which instance of the parameter will be selected.</p>	1 to 4	----	----	----	----	14003	uint RWES
<p><b>Security Setting Menu</b></p>								
<p><b>LoCo</b> [LoC.o]</p>	<p><i>Security Setting</i> <b>Operations Page</b> Change the security level of the Operations Page.</p>	1 to 3	2	----	----	----	3002	uint RWE
<p><b>Note:</b> Some values will be rounded off to fit in the four-character display. Full values can be read with other interfaces.</p> <p><b>If there is only one instance of a menu, no submenus will appear.</b></p>								<p>R: Read W: Write E: EEPROM S: User Set</p>



### Factory Page

Display	Parameter Name Description	Range	Default	Modbus Relative Ad- dress	CIP Class Instance Attribute hex (dec)	Profibus Index	Param- eter ID	Data Type & Read/ Write
<b>[LoC.P]</b> [LoC.P]	<i>Security Setting</i> <b>Profiling Page</b> Change the security level of the Profiling Page.	1 to 3	3	----	----	----	3008	uint RWE
<b>[PASE]</b> [LoC.P]	<i>Security Setting</i> <b>Password Enable</b> Turn security features on or off.	<input type="checkbox"/> <b>OFF</b> Off <input type="checkbox"/> <b>ON</b> On	Off	----	----	----	3009	uint RWE
<b>[rLoC]</b> [rLoC]	<i>Security Setting</i> <b>Read Lock</b> Set the read security clearance level. The user can access the selected level and all lower levels. If the Set Lockout Security level is higher than the Read Lockout Security, the Read Lockout Security level takes priority.	1 to 5	5	----	----	----	3010	uint RWE
<b>[SLoC]</b> [SLoC]	<i>Security Setting</i> <b>Write Security</b> Set the write security clearance level. The user can access the selected level and all lower levels. If the Set Lockout Security level is higher than the Read Lockout Security, the Read Lockout Security level takes priority.	0 to 5	5	----	----	----	3011	uint RWE
<b>[LoC.L]</b> [LoC.L]	<i>Security Setting</i> <b>Locked Access Level</b> Determines user level menu visibility when security is enabled. See Features section under Password Security.	1 to 5	5	----	----	----	3016	uint RWE
<b>[roLL]</b> [roLL]	<i>Security Setting</i> <b>Rolling Password</b> When power is cycled a new Public Key will be displayed.	<input type="checkbox"/> <b>OFF</b> Off <input type="checkbox"/> <b>ON</b> On	Off	----	----	----	3019	uint RWE
<b>[PAS.u]</b> [PAS.u]	<i>Security Setting</i> <b>User Password</b> Used to acquire access to menus made available through the Locked Access Level setting.	10 to 999	63	----	----	----	3017	uint RWE
<b>[PAS.A]</b> [PAS.A]	<i>Security Setting</i> <b>Administrator Password</b> Used to acquire full access to all menus.	10 to 999	156	----	----	----	3018	uint RWE
<b>Note:</b> Some values will be rounded off to fit in the four-character display. Full values can be read with other interfaces.  <b>If there is only one instance of a menu, no submenus will appear.</b>								R: Read W: Write E: EEPROM S: User Set

Factory Page

Display	Parameter Name Description	Range	Default	Modbus Relative Address	CIP Class Instance Attribute hex (dec)	Profibus Index	Parameter ID	Data Type & Read/Write
<b>ULoC</b> <b>FCEY</b> <b>Security Setting Menu</b>								
<b>[CodE]</b> [CodE]	<i>Security Setting</i> <b>Public Key</b> If Rolling Password turned on, generates a random number when power is cycled. If Rolling Password is off fixed number will be displayed.	Customer Specific	0	----	----	----	3020	uint R
<b>[PASS]</b> [PASS]	<i>Security Setting</i> <b>Password</b> Number returned from calculation found in Features section under Password Security.	-1999 to 9999	0	----	----	----	3022	int RW
<b>d.R9</b> <b>FctY</b> <b>Diagnostics Menu</b>								
<b>[Pn]</b> [ Pn]	<i>Diagnostics</i> <b>Part Number</b> Display this controller's part number.	15 characters	----	----	0x65 (101) 1 9	115	1009	string RWE
<b>[rEu]</b> [ rEu]	<i>Diagnostics</i> <b>Software Revision</b> Display this controller's firmware revision number.	1 to 10	----	----	0x65 (101) 1 0x11 (17)	116	1003	string R
<b>[S.bLd]</b> [S.bLd]	<i>Diagnostics</i> <b>Software Build Number</b> Display the firmware build number.	0 to 2,147,483,647	----	<b>Instance 1</b> <i>Map 1</i> <i>Map 2</i> 8            8	0x65 (101) 1 5	----	1005	dint R
<b>[Sn]</b> [ Sn]	<i>Diagnostics</i> <b>Serial Number</b> Display the serial number.	0 to 2,147,483,647	----	----	0x65 (101) 1 0x20 (32)	----	1032	string RWE
<b>[dAtE]</b> [dAtE]	<i>Diagnostics</i> <b>Date of Manufacture</b> Display the date code.	0 to 2,147,483,647	----	<b>Instance 1</b> <i>Map 1</i> <i>Map 2</i> 14          14	0x65 (101) 1 8	----	1008	dint RWE
<b>CAL</b> <b>FCEY</b> <b>Calibration Menu</b>								
<b>[Mv]</b> [ Mv]	<i>Calibration (1 to 2)</i> <b>Electrical Measurement</b> Read the raw electrical value for this input in the units corresponding to the Sensor Type (Setup Page, Analog Input Menu) setting.	-3.4e38 to 3.4e38	----	<b>Instance 1</b> <i>Map 1</i> <i>Map 2</i> 400        400 <b>Instance 2</b> <i>Map 1</i> <i>Map 2</i> 480        490	0x68 (104) 1 to 2 0x15 (21)	----	4021	float R
<b>Note:</b> Some values will be rounded off to fit in the four-character display. Full values can be read with other interfaces.  <b>If there is only one instance of a menu, no submenus will appear.</b>								R: Read W: Write E: EEPROM S: User Set

Factory Page

Display	Parameter Name Description	Range	Default	Modbus Relative Address	CIP Class Instance Attribute hex (dec)	Profibus Index	Parameter ID	Data Type & Read/ Write
<b>[EL<sub>Lo</sub>]</b> [ELi.o]	<i>Calibration (1 to 2)</i> <b>Electrical Input Offset</b> Change this value to calibrate the low end of the input range.	-1,999.000 to 9,999.000	0.0	<b>Instance 1</b> <i>Map 1</i> <i>Map 2</i> 378 378 <b>Instance 2</b> <i>Map 1</i> <i>Map 2</i> 458 468	0x68 (104) 1 to 2 0xA (10)	----	4010	float RWES
<b>[EL<sub>S</sub>]</b> [ELi.S]	<i>Calibration (1 to 2)</i> <b>Electrical Input Slope</b> Adjust this value to calibrate the slope of the input value.	-1,999.000 to 9,999.000	1.0	<b>Instance 1</b> <i>Map 1</i> <i>Map 2</i> 380 380 <b>Instance 2</b> <i>Map 1</i> <i>Map 2</i> 460 470	0x68 (104) 1 to 2 0xB (11)	----	4011	float RWES
<b>[EL<sub>o</sub>]</b> [ELo.o]	<i>Calibration (1 or 3)</i> <b>Electrical Output Offset</b> Change this value to calibrate the low end of the output range. Menu 2 calibrates output 3.	-1,999.000 to 9,999.000	0.0	----	----	----	18005	----
<b>[EL<sub>oS</sub>]</b> [ELo.S]	<i>Calibration (1 or 3)</i> <b>Electrical Output Slope</b> Adjust this value to calibrate the slope of the output value. Menu 2 calibrates output 3.	-1,999.000 to 9,999.000	1.0	----	----	----	18006	----
<b>Note:</b> Some values will be rounded off to fit in the four-character display. Full values can be read with other interfaces.  <b>If there is only one instance of a menu, no submenus will appear.</b>								<b>R:</b> Read <b>W:</b> Write <b>E:</b> EEPROM <b>S:</b> User Set

# 9

## Chapter 9: Features

<b>Saving and Restoring User Settings</b> . . . . .	<b>74</b>
<b>Programming the Home Page</b> . . . . .	<b>74</b>
<b>Tuning the PID Parameters</b> . . . . .	<b>74</b>
Manual Tuning . . . . .	75
Autotuning with TRU-TUNE+ <sup>®</sup> . . . . .	75
<b>Inputs</b> . . . . .	<b>76</b>
Calibration Offset . . . . .	76
Calibration . . . . .	76
Filter Time Constant . . . . .	77
Set Point Low Limit and High Limit . . . . .	77
Scale High and Scale Low . . . . .	77
Range High and Range Low . . . . .	77
<b>Outputs</b> . . . . .	<b>77</b>
Duplex . . . . .	77
NO-ARC Relay . . . . .	78
Retransmitting a Process Value or Set Point . . . . .	78
Cool Output Curve . . . . .	78
<b>Control Methods</b> . . . . .	<b>79</b>
Output Configuration . . . . .	79
Auto (closed loop) and Manual (open loop) Control . . . . .	79
On-Off Control . . . . .	80
Proportional Control . . . . .	80
Proportional plus Integral (PI) Control . . . . .	80
Proportional plus Integral plus Derivative (PID) Control . . . . .	81
Dead Band . . . . .	81
Variable Time Base . . . . .	81
Single Set Point Ramping . . . . .	82
<b>Alarms</b> . . . . .	<b>82</b>
Process and Deviation Alarms . . . . .	82
Alarm Set Points . . . . .	82
Alarm Hysteresis . . . . .	83
Alarm Latching . . . . .	83
Alarm Silencing . . . . .	83
Alarm Blocking . . . . .	83
<b>Open Loop Detection</b> . . . . .	<b>83</b>
<b>Programming the EZ Key/s</b> . . . . .	<b>84</b>
<b>Using Lockout to Hide Pages and Menus</b> . . . . .	<b>84</b>
<b>Using Password Security</b> . . . . .	<b>85</b>
<b>Modbus - Using Programmable Memory Blocks</b> . . . . .	<b>86</b>
<b>Software Configuration</b> . . . . .	<b>87</b>

## Saving and Restoring User Settings

Recording setup and operations parameter settings for future reference is very important. If you unintentionally change these, you will need to program the correct settings back into the controller to return the equipment to operational condition.

After you program the controller and verify proper operation, use User Save Set **[USR.S]** (Setup Page, Global Menu) to save the settings into either of two files in a special section of memory. If the settings in the controller are altered and you want to return the controller to the saved values, use User Restore Set **[USR.R]** (Setup Page, Global Menu) to recall one of the saved settings.

A digital input or the Function Key can also be configured to restore parameters.

### Note:

Only perform the above procedure when you are sure that all the correct settings are programmed into the controller. Saving the settings overwrites any previously saved collection of settings. Be sure to document all the controller settings.

## Programming the Home Page

Watlow's patented user-defined menu system improves operational efficiency. The user-defined Home Page provides you with a shortcut to monitor or change the parameter values that you use most often.

You can create your own Home Page with as many as 20 of the active parameters. When a parameter normally located in the Setup Page or Operations Page is placed in the Home Page, it is accessible through both. If you change a parameter in the Home Page, it is automatically changed in its original page. If you change a parameter in its original page it is automatically changed in the Home Page.

The default parameters will automatically appear in the Home Page.

Change the list of parameters in the Home Page from the Custom Menu **[CUSE]** (Factory Page).

## Tuning the PID Parameters

### Autotuning

When an autotune is performed on the EZ-ZONE PM, the set point is used to calculate the tuning set point.

For example, if the active set point is 200° and Autotune Set Point **[AESP]** (Operations Page, Loop Menu) is set to 90 percent, the autotune function utilizes 180° for tuning. This is also how autotuning works in previous Watlow Winona controllers. In addition, changing the active set point in previous controllers causes the autotune function to restart; where with the EZ-ZONE PM changing the set point

after an autotune has been started has no affect.

A new feature in EZ-ZONE PM products will allow set point changes while the control is autotuning, this includes while running a profile or ramping. When the auto tune is initially started it will use the current set point and will disregard all set point changes until the tuning process is complete. Once complete, the controller will then use the new set point.

This is why it is a good idea to enter the active set point before initiating an autotune.

Autotuning calculates the optimum heating and/or cooling PID parameter settings based on the system's response. Autotuning can be enabled whether or not TUNE-TUNE+® is enabled. The PID settings generated by the autotune will be used until the autotune feature is rerun, the PID values are manually adjusted or TRU-TUNE+® is enabled.

To initiate an autotune, set Autotune Request **[AUT]** (Operations Page, Loop Menu) to **[YES]**. You should not autotune while a profile is running. If the autotune cannot be completed in 60 minutes, the autotune will time-out and the original settings will take effect.

The lower display will flash between **[TUNE]** and the set point while the autotuning is underway. The temperature must cross the Autotune Set Point five times to complete the autotuning process. Once complete, the controller controls at the normal set point, using the new parameters.

Select a set point for the tune with Autotune Set Point. The Autotune Set Point is expressed as a percent of the Closed Loop Set Point.

If you need to adjust the tuning procedure's aggressiveness, use Autotune Aggressiveness **[TAGG]** (Setup Page, Loop Menu). Select under damped **[Undr]** to bring the process value to the set point quickly. Select over damped **[over]** to bring the process value to the set point with minimal overshoot. Select critical damped **[crit]** to balance a rapid response with minimal overshoot.

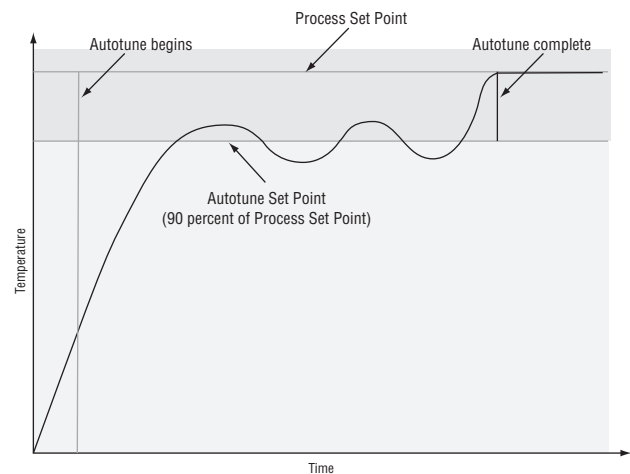

## Manual Tuning

In some applications, the autotune process may not provide PID parameters for the process characteristics you desire. If that is the case, you may want to tune the controller manually.

1. Apply power to the controller and establish a set point typically used in your process.
2. Go to the Operations Page, Loop Menu, and set Heat Proportional Band  and/or Cool Proportional Band  to 5. Set Time Integral  to 0. Set Time Derivative  to 0.
3. When the system stabilizes, watch the process value. If it fluctuates, increase the Heat Proportional Band or Cool Proportional Band value in 3 to 5° increments until it stabilizes, allowing time for the system to settle between adjustments.
4. When the process has stabilized, watch Heat Power  or Cool Power  (Operations Page, Monitor Menu). It should be stable  $\pm 2\%$ . At this point, the process temperature should also be stable, but it will have stabilized before reaching the set point. The difference between the set point and actual process value can be eliminated with Integral.
5. Start with an Integral value of 6,000 and allow 10 minutes for the process temperature to reach the set point. If it has not, reduce the setting by half and wait another 10 minutes. Continue reducing the setting by half every 10 minutes until the process value equals the set point. If the process becomes unstable, the Integral value is too small. Increase the value until the process stabilizes.
6. Increase Derivative to 0.1. Then increase the set point by 11° to 17°C. Monitor the system's approach to the set point. If the process value overshoots the set point, increase Derivative to 0.2. Increase the set point by 11° to 17°C and watch the approach to the new set point. If you increase Derivative too much, the approach to the set point will be very sluggish. Repeat as necessary until the system rises to the new set point without overshoot or sluggishness.

For additional information about autotune and PID control, see related features in this chapter.

---

### Autotuning with TRU-TUNE+®

The TRU-TUNE+® adaptive algorithm will optimize the controller's PID values to improve control of dynamic processes. TRU-TUNE+® monitors the process variable and adjusts the control parameters automatically to keep your process at set point during set point and load changes. When the controller is in the adaptive control mode, it determines the appropriate output signal and, over time, adjusts control parameters to optimize responsiveness and stability. The TRU-TUNE+® feature does not function for on-off control.

The preferred and quickest method for tuning a loop is to establish initial control settings and continue with the adaptive mode to fine tune the settings.

Setting a controller's control mode to tune starts this two-step tuning process. (See Autotuning in this chapter.) This predictive tune determines initial, rough settings for the PID parameters. Then the loop automatically switches to the adaptive mode which fine tunes the PID parameters.

Once the process variable has been at set point for a suitable period (about 30 minutes for a fast process to roughly two hours for a slower process) and if no further tuning of the PID parameters is desired or needed, TRU-TUNE+® may be turned off. However, keeping the controller in the adaptive mode allows it to automatically adjust to load changes and compensate for differing control characteristics at various set points for processes that are not entirely linear.

Once the PID parameters have been set by the TRU-TUNE+® adaptive algorithm, the process, if shut down for any reason, can be restarted in the adaptive control mode.

Turn TRU-TUNE+® on or off with TRU-TUNE+® Enable  (Setup Page, Loop Menu).

Use TRU-TUNE+® Band  (Setup Page, Loop Menu) to set the range above and below the set point in which adaptive tuning will be active. Adjust this parameter only in the unlikely event that the controller is unable to stabilize at the set point with TRU-TUNE+® Band set to auto (0). This may occur with very fast processes. In that case, set TRU-TUNE+™ Band to a large value, such as 100.

Use TRU-TUNE+® Gain  (Setup Page, Loop Menu) to adjust the responsiveness of the adaptive tuning calculations. Six settings range from 1, with the most aggressive response and most potential overshoot (highest gain), to 6, with the least aggressive response and least potential for overshoot (lowest gain). The default setting, 3, is recommended for loops with thermocouple feedback and moderate response and overshoot potential.

### Before Tuning

Before autotuning, the controller hardware must be installed correctly, and these basic configuration parameters must be set:

- Sensor Type  (Setup Page, Analog Input Menu), and scaling, if required;
- Function  (Setup Page, Output Menu) and scaling, if required.

### How to Autotune a Loop

1. Enter the desired set point or one that is in the middle of the expected range of set points that you want to tune for.
2. Enable TRU-TUNE+®.
3. Initiate an autotune. (See Autotuning in this chapter.)

When autotuning is complete, the PID parameters should provide good control. As long as the loop is in the adaptive control mode, TRU-TUNE+® continuously tunes to provide the best possible PID control for the process.



**WARNING! During autotuning, the controller sets the output to 100 percent and attempts to drive the process variable toward the set point. Enter a set point and heat and cool power limits that are within the safe operating limits of your system.**

## Inputs

### Calibration Offset

Calibration offset allows a device to compensate for an inaccurate sensor, lead resistance or other factors that affect the input value. A positive offset increases the input value, and a negative offset decreases the input value.

The input offset value can be viewed or changed with Calibration Offset  (Operations Page, Analog Input Menu).

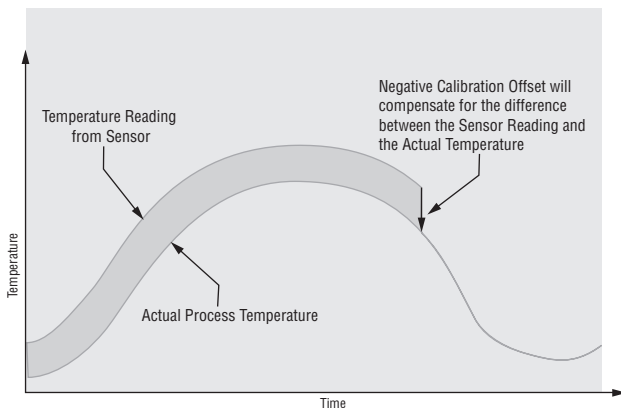

### Calibration

To calibrate an analog input, you will need to provide two electrical signals or resistance loads near the extremes of the range that the application is likely to utilize. See recommended values below:

Sensor Type	Low Source	High Source
thermocouple	0.000 mV	50.000 mV
millivolts	0.000 mV	50.000 mV
volts	0.000V	10.000V
milliamps	0.000 mA	20.000 mA
100 Ω RTD	50.00 Ω	350.00 Ω
1,000 Ω RTD	500.00 Ω	3,500.00 Ω
Thermistor 5K	50.00 Ω	5000.00 Ω
Thermistor 10K	50.00 Ω	10000.00 Ω
Thermistor 20K	50.00 Ω	20000.00 Ω
Thermistor 40K	50.00 Ω	40000.00 Ω

### Follow these steps for a thermocouple or process input:

1. Apply the low source signal to the input you are calibrating. Measure the signal to ensure it is accurate.
2. Read the value of Electrical Measurement  (Factory Page, Calibration Menu) for that input.
3. Calculate the offset value by subtracting this value from the low source signal.
4. Set Electrical Input Offset  (Factory Page, Calibration Menu) for this input to the offset value.
5. Check the Electrical Measurement to see whether it now matches the signal. If it doesn't match, adjust Electrical Input Offset again.
6. Apply the high source signal to the input. Measure the signal to ensure it is accurate.
7. Read the value of Electrical Measurement for that input.
8. Calculate the gain value by dividing the low source signal by this value.
9. Set Electrical Input Slope  (Factory Page, Calibration Menu) for this input to the calculated gain value.
10. Check the Electrical Measurement to see whether it now matches the signal. If it doesn't match, adjust Electrical Input Slope again.

Set Electrical Input Offset to 0 and Electrical Input Slope to 1 to restore factory calibration.

### Follow these steps for an RTD input:

1. Measure the low source resistance to ensure it is accurate. Connect the low source resistance to the input you are calibrating.
2. Read the value of Electrical Measurement  (Factory Page, Calibration Menu) for that input.
3. Calculate the offset value by subtracting this value from the low source resistance.
4. Set Electrical Input Offset  (Factory Page, Calibration Menu) for this input to the offset value.
5. Check the Electrical Measurement to see whether it now matches the resistance. If it doesn't match, adjust Electrical Offset again.
6. Measure the high source resistance to ensure it is accurate. Connect the high source resistance to the input.
7. Read the value of Electrical Measurement for that input.
8. Calculate the gain value by dividing the low source signal by this value.
9. Set Electrical Input Slope  (Factory Page, Calibration Menu) for this input to the calculated gain value.
10. Check the Electrical Measurement to see whether it now matches the signal. If it doesn't match, adjust Electrical Input Slope again.

Set Electrical Input Offset to 0 and Electrical Input Slope to 1 to restore factory calibration.

## Filter Time Constant

Filtering smoothes an input signal by applying a first-order filter time constant to the signal. Filtering the displayed value makes it easier to monitor. Filtering the signal may improve the performance of PID control in a noisy or very dynamic system.

Adjust the filter time interval with Filter Time

(Setup Page, Analog Input Menu).

Example: With a filter value of 0.5 seconds, if the process input value instantly changes from 0 to 100 and remained at 100, the display will indicate 100 after five time constants of the filter value or 2.5 seconds.

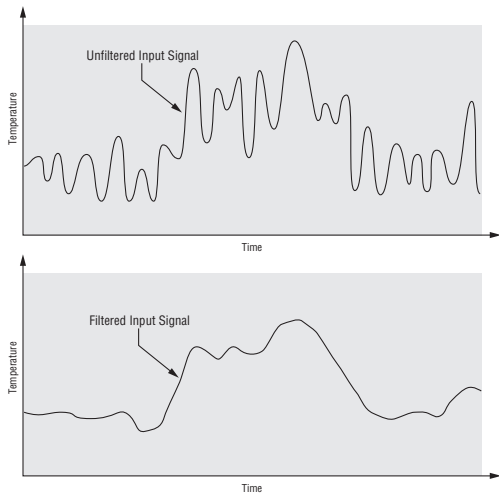

## Sensor Selection

You need to configure the controller to match the input device, which is normally a thermocouple, RTD or process transmitter.

Select the sensor type with Sensor Type

(Setup Page, Analog Input Menu).

## Set Point Low Limit and High Limit

The controller constrains the set point to a value between a set point low limit and a set point high limit.

Set the set point limits with Low Set Point

and High Set Point  (Setup Page,

Loop Menu).

There are two sets of set point low and high limits: one for a closed-loop set point, another for an open-loop set point.

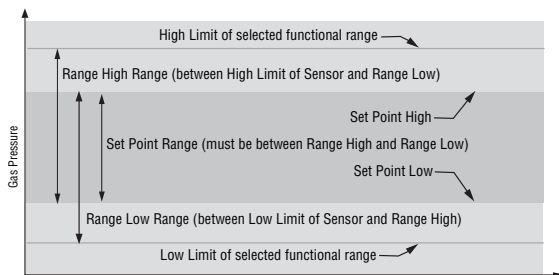

## Scale High and Scale Low

When an analog input is selected as process voltage or process current input, you must choose the value of voltage or current to be the low and high ends. For example, when using a 4 to 20 mA input, the scale low value would be 4.00 mA and the scale high value would be 20.00 mA. Commonly used scale ranges are: 0 to 20 mA, 4 to 20 mA, 0 to 5V, 1 to 5V and 0 to 10V.

You can create a scale range representing other units for special applications. You can reverse scales from high values to low values for analog input signals that have a reversed action. For example, if 50 psi causes a 4 mA signal and 10 psi causes a 20 mA signal.

Scale low and high low values do not have to match the bounds of the measurement range. These along with range low and high provide for process scaling and can include values not measurable by the controller. Regardless of scaling values, the measured value will be constrained by the electrical measurements of the hardware.

Select the low and high values with Scale Low  and Scale High . Select the displayed range with Range Low  and Range High  (Setup Page, Analog Input Menu).

## Range High and Range Low

With a process input, you must choose a value to represent the low and high ends of the current or voltage range. Choosing these values allows the controller's display to be scaled into the actual working units of measurement. For example, the analog input from a humidity transmitter could represent 0 to 100 percent relative humidity as a process signal of 4 to 20 mA. Low scale would be set to 0 to represent 4 mA and high scale set to 100 to represent 20 mA. The indication on the display would then represent percent humidity and range from 0 to 100 percent with an input of 4 to 20 mA.

Select the low and high values with Range Low  and Range High  (Setup Page, Analog Input Menu).

## Outputs

### Duplex

Certain systems require that a single process output control both heating and cooling outputs. An EZ-ZONE PM controller with a process output can function as two separate outputs.

With a 4 to 20mA output the heating output will operate from 12 to 20mA (0 to +100 percent) and the cooling output will operate from 12 to 4mA (0 to -100 percent).

In some cases this type of output is required by the device that the EZ-ZONE PM controls, such as a three-way valve that opens one way with a 12 to



20mA signal and opens the other way with a 4 to 12mA signal. This feature reduces the overall system cost by using a single output to act as two outputs.

Outputs 1 and 3 can be ordered as process outputs. Select duplex **[DUPL]** as the Output Function **[Fn]** (Setup Page, Output Menu). Set the output to volts **[VOLT]** or milliamps **[MMA]** with Output Type **[OUTY]**. Set the range of the process output with Scale Low **[SL0]** and Scale High **[SHI]**.

---

## NO-ARC Relay

A NO-ARC relay provides a significant improvement in the life of the output relay over conventional relays.

Conventional mechanical relays have an expected life of 100,000 cycles at the rated full-load current. The shorter life for conventional relays is due to the fact that when contacts open while current is flowing metal degradation occurs. This action produces unavoidable electrical arcing causing metal to transfer from one contact to the other. The arcing conditions continue on each subsequent contact opening until over time the resistance through the contacts increases causing the contacts to increase in temperature. Eventually, the contacts will weld together and the relay remains in the on state.

The Watlow NO-ARC relay is a hybrid relay. It uses a mechanical relay for the current load and a triac (solid-state switch) to carry the turn-on and turn-off currents. NO-ARC relays extend the life of the relay more than two million cycles at the rated full-load current.

Although a NO-ARC relay has significant life advantages, a few precautions must be followed for acceptable usage:

### Do not use:

- hybrid relays for limit contactors. A limit or safety device must provide a positive mechanical break on all hot legs simultaneously;
- dc loads with hybrid relays. The triacs used for arc suppression will turn off only with ac line voltage;
- hybrid switches to drive any inductive loads, such as relay coils, transformers or solenoids;
- cycle times less than five seconds on hybrid switches;
- on loads that exceed 264V ac through relay;
- on loads that exceed 15 amperes load;
- on loads less than 100 mA;
- NO-ARC relays in series with other NO-ARC relays.

---

## Retransmitting a Process Value or Set Point

The retransmit feature allows a process output to provide an analog signal that represents the set point or process value. The signal may serve as a remote set point for another controller or as an in-

put for a chart recorder documenting system performance over time.

In choosing the type of retransmit signal the operator must take into account the input impedance of the device to be retransmitted to and the required signal type, either voltage or milliamps.

Typically applications might use the retransmit option to record one of the variables with a chart recorder or to generate a set point for other controls in a multi-zone application.

Output 1 can be ordered as process outputs. Select retransmit **[RMA]** as the Output Function **[Fn]** (Setup Page, Output Menu). Set the output to volts **[VOLT]** or milliamps **[MMA]** with Output Type **[OUTY]**. Select the signal to retransmit with Retransmit Source **[RSR]**.

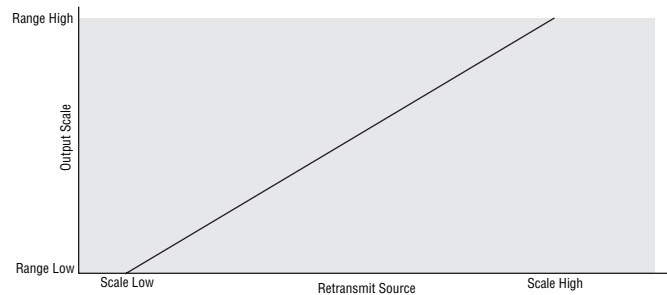

Set the range of the process output with Scale Low **[SL0]** and Scale High **[SHI]**. Scale the retransmit source to the process output with Range Low **[RL0]** and Range High **[RHI]**.

When the retransmit source is at the Range Low value, the retransmit output will be at its Scale Low value. When the retransmit source is at the Range High value, the retransmit output will be at its Scale High value.

---

## Cool Output Curve

A nonlinear output curve may improve performance when the response of the output device is nonlinear. If a cool output uses one of the nonlinear curves a PID calculation yields a lower actual output level than a linear output would provide.

These output curves are used in plastics extruder applications: curve 1 for oil-cooled extruders and curve 2 for water-cooled extruders.

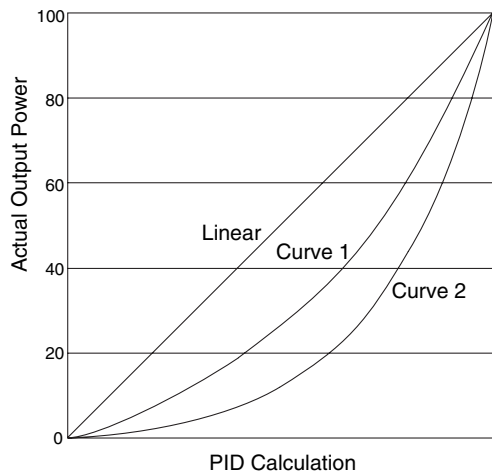

Select a nonlinear cool output curve with Cool Output Curve  **CCr** (Setup Menu, Loop Menu).

## Control Methods

### Output Configuration

Each controller output can be configured as a heat output, a cool output, an alarm output or deactivated. No dependency limitations have been placed on the available combinations. The outputs can be configured in any combination. For instance, all three could be set to cool.

Heat and cool outputs use the set point and Operations parameters to determine the output value. All heat and cool outputs use the same set point value. Heat and cool each have their own set of control parameters. All heat outputs use the same set of heat control parameters and all cool outputs use the same set of cool output parameters.

Each alarm output has its own set of configuration parameters and set points, allowing independent operation.

### Auto (closed loop) and Manual (open loop) Control

The controller has two basic modes of operation, auto mode and manual mode. Auto mode allows the controller to decide whether to perform closed-loop control or to follow the settings of Input Error Failure  **FRIL** (Setup Page, Loop Menu). The manual mode only allows open-loop control. The EZ-ZONE PM controller is normally used in the auto mode. The manual mode is usually only used for specialty applications or for troubleshooting.

Manual mode is open-loop control that allows the user to directly set the power level to the controller's output load. No adjustments of the output power level occur based on temperature or set point in this mode.

In auto mode, the controller monitors the input to determine if closed-loop control is possible. The controller checks to make certain a functioning sensor is providing a valid input signal. If a valid input signal

is present, the controller will perform closed-loop control. Closed-loop control uses a process sensor to determine the difference between the process value and the set point. Then the controller applies power to a control output load to reduce that difference.

If a valid input signal is not present, the controller will indicate an input error message in the upper display and  **REEn** in the lower display and respond to the failure according to the setting of Input Error Failure  **FRIL**. You can configure the controller to perform a "bumpless" transfer  **bPLS**, switch power to output a preset fixed level  **PRRn**, or turn the output power off.

Bumpless transfer will allow the controller to transfer to the manual mode using the last power value calculated in the auto mode if the process had stabilized at a  $\pm 5$  percent output power level for the time interval of Time Integral (Operations Page, Loop) prior to sensor failure, and that power level is less than 75 percent.

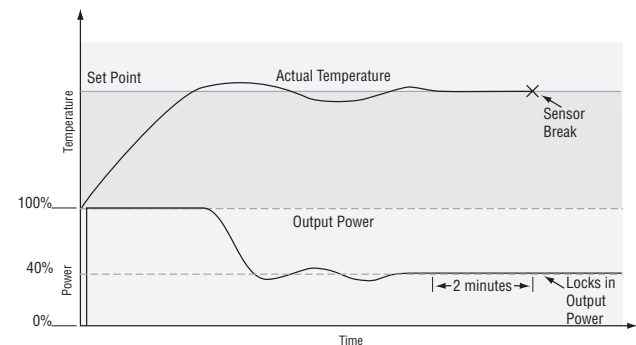

Input Error Latching  **IER** (Setup Page, Analog Input Menu) determines the controller's response once a valid input signal returns to the controller. If latching is on, then the controller will continue to indicate an input error until the error is cleared. To clear a latched alarm, press the Advance Key  then the Up Key .

If latching is off, the controller will automatically clear the input error and return to reading the temperature. If the controller was in the auto mode when the input error occurred, it will resume closed-loop control. If the controller was in manual mode when the error occurred, the controller will remain in open-loop control.

The Manual Control Indicator Light % is on when the controller is operating in manual mode.

You can easily switch between modes if the Control Mode  **CR7** parameter is selected to appear in the Home Page.

To transfer to manual mode from auto mode, press the Advance Key  until  **CR7** appears in the lower display. The upper display will display  **AUTe** for auto mode. Use the Up  or Down  keys to select  **PRRn**. The manual set point value will be recalled from the last manual operation.

To transfer to auto mode from manual mode, press the Advance Key  until  **CR7** appears in the lower display. The upper display will display

**PRRn** for manual mode. Use the Up **▲** or Down **▼** keys to select **Auto**. The automatic set point value will be recalled from the last automatic operation.

Changes take effect after three seconds or immediately upon pressing either the Advance Key **⏩** or the Infinity Key **∞**.

## On-Off Control

On-off control switches the output either full on or full off, depending on the input, set point and hysteresis values. The hysteresis value indicates the amount the process value must deviate from the set point to turn on the output. Increasing the value decreases the number of times the output will cycle. Decreasing hysteresis improves controllability. With hysteresis set to 0, the process value would stay closer to the set point, but the output would switch on and off more frequently, and may result in the output “chattering.”

On-off control can be selected with Heat Algorithm **hA9** or Cool Algorithm **CA9** (Setup Page, Loop Menu).

On-off hysteresis can be set with Heat Hysteresis **hh9** or Cool Hysteresis **Ch9** (Operations Page, Loop Menu).

### Note:

Input Error Failure Mode **FRIL** does not function in on-off control mode. The output goes off.

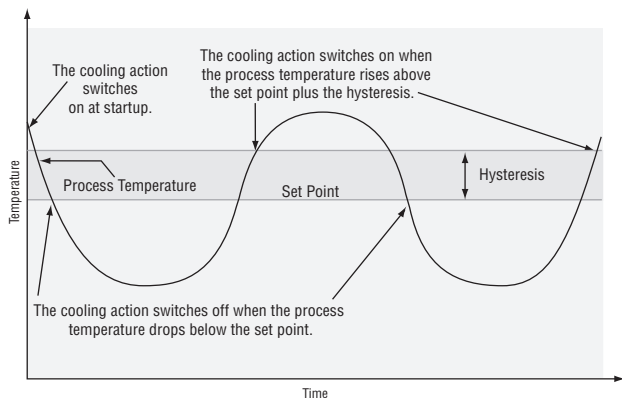
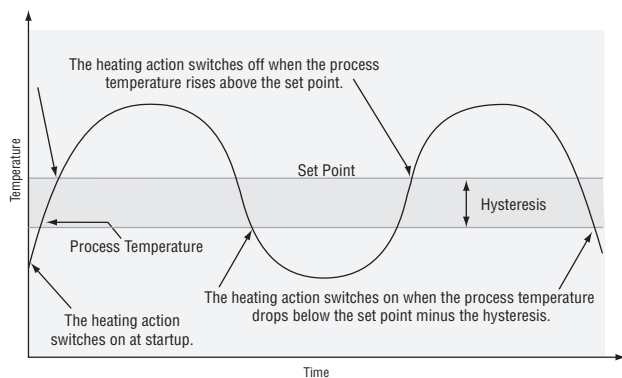

## Proportional Control

Some processes need to maintain a temperature or process value closer to the set point than on-off control can provide. Proportional control provides closer control by adjusting the output when the temperature or process value is within a proportional band. When the value is in the band, the controller adjusts the output based on how close the process value is to the set point.

The closer the process value is to the set point, the lower the output power. This is similar to backing off on the gas pedal of a car as you approach a stop sign. It keeps the temperature or process value from swinging as widely as it would with simple on-off control. However, when the system settles down, the temperature or process value tends to “droop” short of the set point.

With proportional control the output power level equals (set point minus process value) divided by the proportional band value.

In an application with one output assigned to heating and another assigned to cooling, each will have a separate proportional parameter. The heating parameter takes effect when the process temperature is lower than the set point, and the cooling parameter takes effect when the process temperature is higher than the set point.

Adjust the proportional band with Heat Proportional Band **hPb** or Cool Proportional Band **CPb** (Operations Page, Loop Menu).

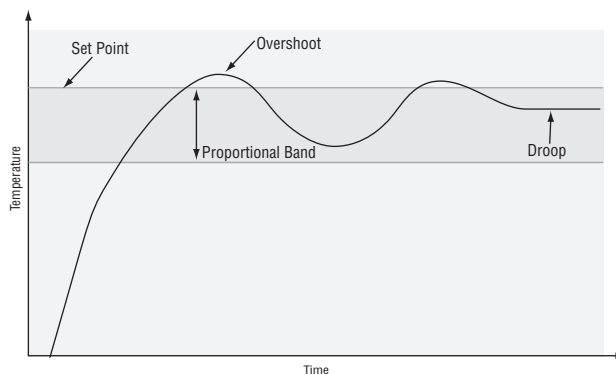

## Proportional plus Integral (PI) Control

The droop caused by proportional control can be corrected by adding integral (reset) control. When the system settles down, the integral value is tuned to bring the temperature or process value closer to the set point. Integral determines the speed of the correction, but this may increase the overshoot at startup or when the set point is changed. Too much integral action will make the system unstable. Integral is cleared when the process value is outside of the proportional band.

Adjust the integral with Time Integral **tI** (Operations Page, Loop Menu).

## Proportional plus Integral plus Derivative (PID) Control

Use derivative (rate) control to minimize the overshoot in a PI-controlled system. Derivative (rate) adjusts the output based on the rate of change in the temperature or process value. Too much derivative (rate) will make the system sluggish.

Derivative action is active only when the process value is within twice the proportional value from the set point.

Adjust the derivative with Time Derivative

(Operations Page, Loop Menu).

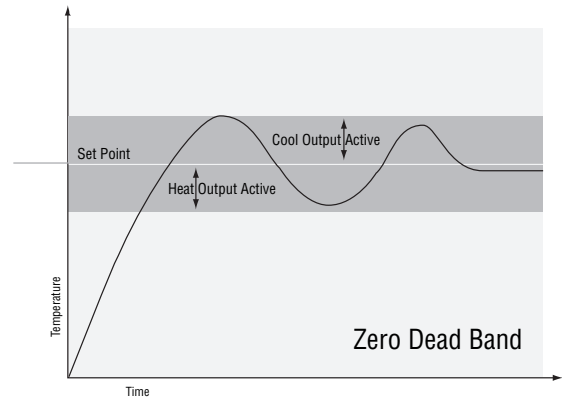
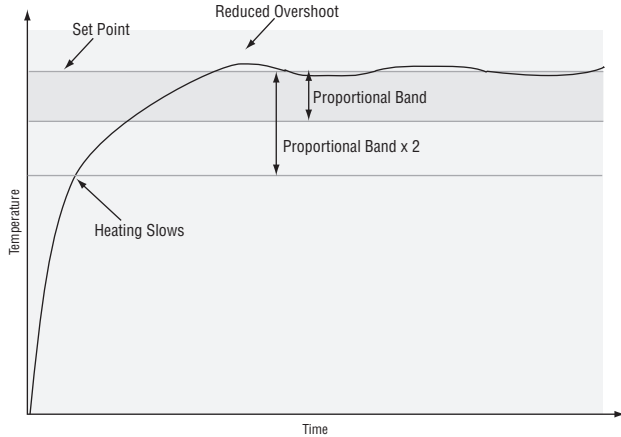

When the **dead band value is a negative value**, both heating and cooling outputs are active when the temperature is near the set point.

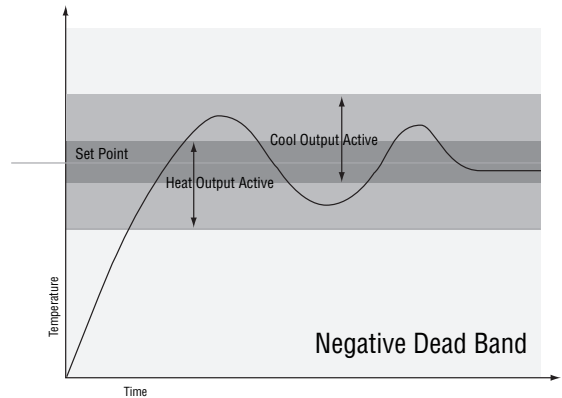

Adjust the dead band with Dead Band  (Operations Page, Loop Menu).

## Dead Band

In a PID application the dead bands above and below the set point can save an application's energy and wear by maintaining process temperature within acceptable ranges.

Proportional action ceases when the process value is within the dead band. Integral action continues to bring the process temperature to the set point.

Using a **positive dead band value** keeps the two systems from fighting each other.

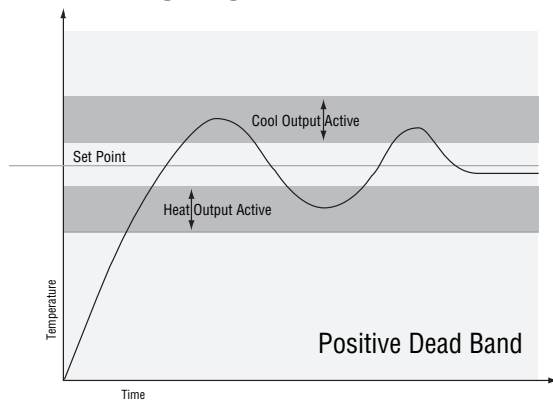

When the **dead band value is zero**, the heating output activates when the temperature drops below the set point, and the cooling output switches on when the temperature exceeds the set point.

## Variable Time Base

Variable time base is the preferred method for controlling a resistive load, providing a very short time base for longer heater life. Unlike phase-angle firing, variable-time-base switching does not limit the current and voltage applied to the heater.

With variable time base outputs, the PID algorithm calculates an output between 0 and 100%, but the output is distributed in groupings of three ac line cycles. For each group of three ac line cycles, the controller decides whether the power should be on or off. There is no fixed cycle time since the decision is made for each group of cycles. When used in conjunction with a zero cross (burst fire) device, such as a solid-state power controller, switching is done only at the zero cross of the ac line, which helps reduce electrical noise (RFI).

Variable time base should be used with solid-state power controllers, such as a solid-state relay (SSR) or silicon controlled rectifier (SCR) power controller. Do not use a variable time base output for controlling electromechanical relays, mercury displacement relays, inductive loads or heaters with unusual resistance characteristics.

The combination of variable time base output and a solid-state relay can inexpensively approach the ef-

fect of analog, phase-angle fired control.

Select the AC Line Frequency **ACLF** (Setup Page, Global Menu), 50 or 60 Hz.

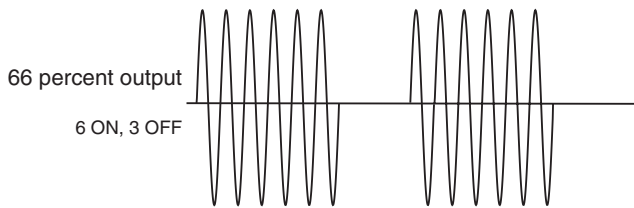
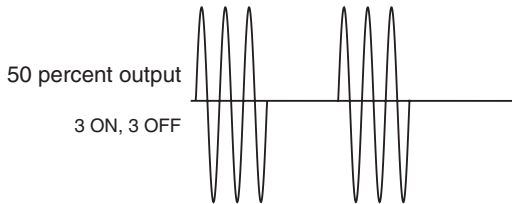
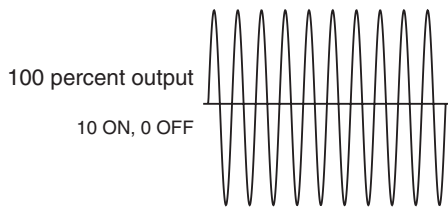

**Note:**

When output 1 is a universal process output, output 2 cannot use variable time base, fixed time base only.

**Single Set Point Ramping**

Ramping protects materials and systems that cannot tolerate rapid temperature changes. The value of the ramp rate is the maximum degrees per minute or hour that the system temperature can change.

Select Ramp Action **RP** (Setup Page, Loop Menu):

- OFF** ramping not active.
- Str** ramp at startup.
- SEPT** ramp at a set point change.
- both** ramp at startup or when the set point changes.

Select whether the rate is in degrees per minute or degrees per hour with Ramp Scale **rSC**. Set the ramping rate with Ramp Rate **rRT** (Setup Page, Loop Menu).

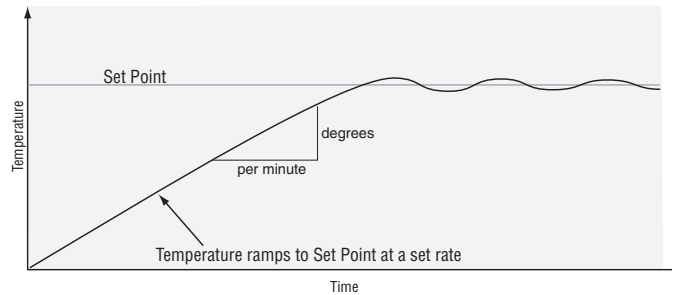
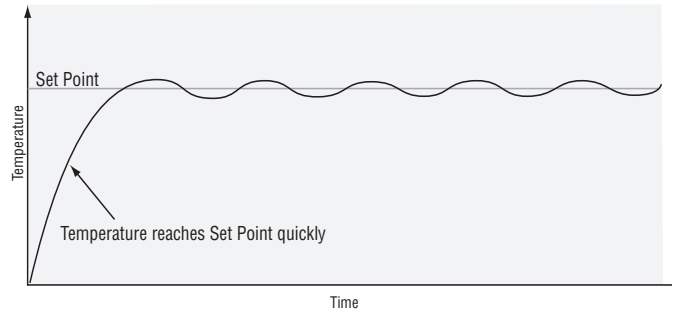

**Alarms**

Alarms are activated when the output level, process value or temperature leaves a defined range. A user can configure how and when an alarm is triggered, what action it takes and whether it turns off automatically when the alarm condition is over.

Configure alarm outputs in the Setup Page before setting alarm set points.

Alarms do not have to be assigned to an output. Alarms can be monitored and controlled through the front panel or by using software.

**Process and Deviation Alarms**

A process alarm uses one or two absolute set points to define an alarm condition.

A deviation alarm uses one or two set points that are defined relative to the control set point. High and low alarm set points are calculated by adding or subtracting offset values from the control set point. If the set point changes, the window defined by the alarm set points automatically moves with it.

Select the alarm type with Type **ALY** (Setup Page, Alarm Menu).

**Alarm Set Points**

The alarm high set point defines the process value or temperature that will trigger a high side alarm. It must be higher than the alarm low set point and lower than the high limit of the sensor range.

The alarm low set point defines the temperature that will trigger a low side alarm. It must be lower than the alarm high set point and higher than the low limit of the sensor range.

View or change alarm set points with Low Set Point **[RL0]** and High Set Point **[Rh1]** (Operations Page, Alarm Menu).

## Alarm Hysteresis

An alarm state is triggered when the process value reaches the alarm high or alarm low set point. Alarm hysteresis defines how far the process must return into the normal operating range before the alarm can be cleared.

Alarm hysteresis is a zone inside each alarm set point. This zone is defined by adding the hysteresis value to the alarm low set point or subtracting the hysteresis value from the alarm high set point.

View or change alarm hysteresis with Hysteresis **[RHY]** (Setup Page, Alarm Menu).

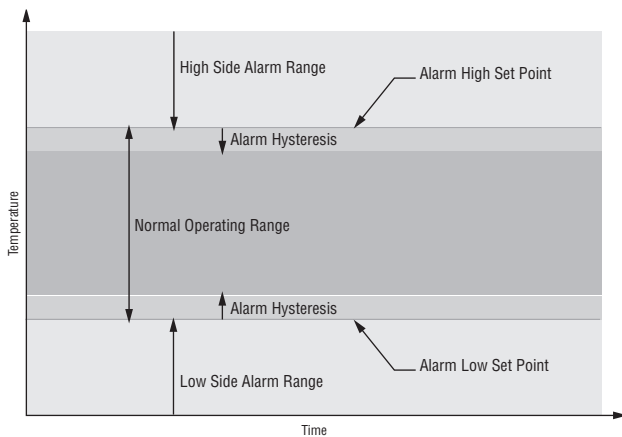

## Alarm Latching

A latched alarm will remain active after the alarm condition has passed. It can only be deactivated by the user.

An active message, such as an alarm message, will cause the display to toggle between the normal settings and the active message in the upper display and **[ALen]** in the lower display.

Push the Advance Key to display **[.9nr]** in the upper display and the message source in the lower display.

Use the Up **▲** and Down **▼** keys to scroll through possible responses, such as Clear **[CLR]** or Silence **[SIL]**. Then push the Advance **⊙** or Infinity **⊕** key to execute the action.

See the Keys and Displays chapter and the Home Page chapter for more details.

An alarm that is not latched (self-clearing) will deactivate automatically when the alarm condition has passed.

Turn alarm latching on or off with Latching **[RLR]** (Setup Page, Alarm Menu).

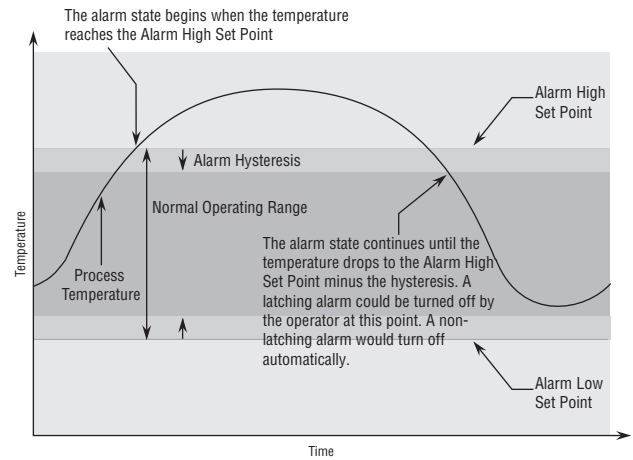

## Alarm Silencing

If alarm silencing is on the operator can disable the alarm output while the controller is in an alarm state. The process value or temperature has to enter the normal operating range beyond the hysteresis zone to activate the alarm output function again.

An active message, such as an alarm message, will cause the display to toggle between the normal settings and the active message in the upper display and **[ALen]** in the lower display.

Push the Advance Key to display **[.9nr]** in the upper display and the message source in the lower display.

Use the Up **▲** and Down **▼** keys to scroll through possible responses, such as Clear **[CLR]** or Silence **[SIL]**. Then push the Advance **⊙** or Infinity **⊕** key to execute the action.

See the Keys and Displays chapter and the Home Page chapter for more details.

Turn alarm silencing on or off with Silencing **[RSI]** (Setup Page, Alarm Menu).

## Alarm Blocking

Alarm blocking allows a system to warm up after it has been started up. With alarm blocking on, an alarm is not triggered when the process temperature is initially lower than the alarm low set point or higher than the alarm high set point. The process temperature has to enter the normal operating range beyond the hysteresis zone to activate the alarm function.

If the EZ-ZONE PM has an output that is functioning as a deviation alarm, the alarm is blocked when the set point is changed, until the process value re-enters the normal operating range.

Turn alarm blocking on or off with Blocking **[RBL]** (Setup Page, Alarm Menu).

## Open Loop Detection

When Open Loop Detection is enabled **[LODE]**, the controller will look for the power output to be at

100%. Once there, the control will then begin to monitor the Open Loop Detect Deviation [Ldd] as it relates to the value entered for the Open Loop Detect Time [LdE]. If the specified time period expires and the deviation does not occur, an Open Loop Error will be triggered. Once the Open Loop Error condition exists the control mode will go off.

**Note:**

All prompts identified in this section can be found in the Loop Menu of the Setup Page.

## Programming the EZ Key/s

You can program the EZ Key either in the Setup Menu or with configuration software, such as EZ-ZONE Configurator, using a personal computer.

The following examples show how to program the EZ Key to start and stop a profile.

### Using keys and display:

- To go to the Setup Page from the Home Page, press both the Up ▲ and Down ▼ keys for six seconds. [R] will appear in the upper display and [SEE] will appear in the lower display.
- Press the Up Key ▲ until [Fun] appears in the upper display and [SEE] will appear in the lower display.
- Press the Advance Key Ⓞ until Digital Input Level [LEu] appears in the lower display. Use an arrow key to specify the state of the key (high or low) when the controller is powered up. Functions will toggle with each press of the EZ Key, such as Profile Start/Stop.
- Press the Advance Key Ⓞ. The lower display will show Digital Function [Fn]. Press the Up ▲ or Down ▼ key to scroll through the functions that can be assigned to the EZ Key  
When Profile Start/Stop [PSES] appears in the upper display and [Fn] appears in the lower display, press the Advance Key Ⓞ once to select that function and move to the Function Instance [FS] parameter.
- Press the Up ▲ or Down ▼ key to scroll to the profile that you want the EZ Key to control.
- The instance tells the controller which of the numbered functions should be acted upon. For profiles, there are 4 instances. Press the Infinity Key ∞ once to return to the submenu, twice to return to the main menu or three times to return to the Home Page.

## Using Lockout to Hide Pages and Menus

If unintentional changes to parameter settings might raise safety concerns or lead to downtime, you can use the lockout feature to make them more secure.

Each of the menus in the Factory Page and each of the pages, except the Factory Page, has a security

level assigned to it. You can change the read and write access to these menus and pages by using the parameters in the Lockout Menu (Factory Page).

## Lockout Menu

There are five parameters in the Lockout Menu (Factory Page):

- Lock Operations Page [LoCo] sets the security level for the Operations Page. (default: 2)

**Note:**

The Home and Setup Page lockout levels are fixed and cannot be changed.

- Lock Profiling Page [LoCP] sets the security level for the Profiling Page. (default: 3)
- Password Security Enable [PSE] will turn on or off the Password security feature. (default: off)
- Read Lockout Security [rLoC] determines which pages can be accessed. The user can access the selected level and all lower levels. (default: 5)
- Set Lockout Security [SLoC] determines which parameters within accessible pages can be written to. The user can write to the selected level and all lower levels. (default: 5)

The table below represents the various levels of lockout for the Set Lockout Security prompt and the Read Lockout Security prompt. The Set Lockout has 6 levels (0-5) of security where the Read Lockout has 5 (1-5). Therefore, level "0" applies to Set Lockout only. "Y" equates to yes (can write/read) where "N" equates to no (cannot write/read). The colored cells simply differentiate one level from the next.

Lockout Security [SLoC] & [rLoC]						
Lockout Level	0	1	2	3	4	5
Home Page	Y	Y	Y	Y	Y	Y
Operations Page	N	N	Y	Y	Y	Y
Setup Page	N	N	N	N	Y	Y
Profile Page	N	N	N	Y	Y	Y
Factory Page						
Custom Menu	N	N	N	N	N	Y
Diagnostic Menu	N	Y	Y	Y	Y	Y
Calibration Menu	N	N	N	N	N	Y
Lockout Menu						
[LoCo]	N	Y	Y	Y	Y	Y
[LoCP]	N	Y	Y	Y	Y	Y
[PSE]	N	Y	Y	Y	Y	Y
[rLoC]	Y	Y	Y	Y	Y	Y
[SLoC]	Y	Y	Y	Y	Y	Y

The following examples show how the Lockout Menu parameters may be used in applications:

- You can lock out access to the Operations Page but allow an operator access to the Profile Menu, by changing the default Profile Page and Operations Page security levels. Change Lock Operations Page [LoCo] to 3 and Lock Profiling Page

**LoCP** to 2. If Set Lockout Security **SLoC** is set to 2 or higher and the Read Lockout Security **rLoC** is set to 2, the Profiling Page and Home Pages can be accessed, and all writable parameters can be written to. Pages with security levels greater than 2 will be locked out (unaccessible).

2. If Set Lockout Security **SLoC** is set to 0 and Read Lockout Security **rLoC** is set to 5, all pages will be accessible, however, changes will not be allowed on any pages or menus, with one exception: Set Lockout Security **SLoC** can be changed to a higher level.

3. The operator wants to read all the menus and not allow any parameters to be changed.

In the Factory Page, Lockout Menu, set Read Lockout Security **rLoC** to 5 and Set Lockout Security **SLoC** to 0.

4. The operator wants to read and write to the Home Page and Profiling Page, and lock all other pages and menus.

In the Factory Page, Lockout Menu, set Read Lockout Security **rLoC** to 2 and Set Lockout Security **SLoC** to 2.

In the Factory Page, Lockout Menu, set Lock Operations Page **LoCO** to 3 and Lock Profiling Page **LoCP** to 2.

5. The operator wants to read the Operations Page, Setup Page, Profiling Page, Diagnostics Menu, Lock Menu, Calibration Menu and Custom Menus. The operator also wants to read and write to the Home Page.

In the Factory Page, Lockout Menu, set Read Lockout Security **rLoC** to 1 and Set Lockout Security **SLoC** to 5.

In the Factory Page, Lockout Menu, set Lock Operations Page **LoCO** to 2 and Lock Profiling Page **LoCP** to 3.

## Using Password Security

It is sometimes desirable to apply a higher level of security to the control where a limited number of menus are visible and not providing access to others without a security password. Without the appropriate password those menus will remain inaccessible. If Password Enabled **PRSE** in the Factory Page under the **LoC** Menu is set to on, an overriding Password Security will be in effect. When in effect, the only Pages that a User without a password has visibility to are defined in the Locked Access Level **LoCL** prompt. On the other hand, a User with a password would have visibility restricted by the Read Lockout Security **rLoC**. As an example, with Password Enabled and the Locked Access Level **LoCL** set to 1 and **rLoC** is set to 3, the available Pages for a User without a password would be limited to the Home and Factory Pages (locked level 1). If the User password is entered all pages would be accessible with the exception of the Setup Page as defined by level 3 access.

## How to Enable Password Security

Go to the Factory Page by holding down the Infinity **∞** key and the Advance **⊕** key for approximately six seconds. Once there, push the Down **▼** key one time to get to the **LoC** menu. Again push the Advance **⊕** key until the Password Enabled **PRSE** prompt is visible. Lastly, push either the up or down key to turn it on. Once on, 4 new prompts will appear:

1. **LoCL**, Locked Access Level (1 to 5) corresponding to the lockout table above.
2. **roLL**, Rolling Password will change the Customer Code every time power is cycled.
3. **PRSe**, User Password which is needed for a User to acquire access to the control.
4. **PRsR**, Administrator Password which is needed to acquire administrative access to the control.

The Administrator can either change the User and or the Administrator password or leave them in the default state. Once Password Security is enabled they will no longer be visible to anyone other than the Administrator. As can be seen in the formula that follows either the User or Administrator will need to know what those passwords are to acquire a higher level of access to the control. Back out of this menu by pushing the Infinity **∞** key. Once out of the menu, the Password Security will be enabled.

## How to Acquire Access to the Control

To acquire access to any inaccessible Pages or Menus, go to the Factory Page and enter the **ULoC** menu. Once there follow the steps below:

### Note:



If Password Security (Password Enabled **PRSE** is On) is enabled the two prompts mentioned below in the first step will not be visible. If unknown, call the individual or company that originally set-up the control.

1. Acquire either the User Password **PRSe** or the Administrator Password **PRsR**.
2. Push the Advance **⊕** key one time where the Code **CoDE** prompt will be visible.

### Note:

- a. If the the Rolling Password is off push the Advance key one more time where the Password **PRSS** prompt will be displayed. Proceed to either step 7a or 8a. Pushing the Up **▲** or Down **▼** arrow keys enter either the User or Administrator Password. Once entered, push and hold the Infinity **∞** key for two seconds to return to the Home Page.
  - b. If the Rolling Password **roLL** was turned on proceed on through steps 3 - 9.
3. Assuming the Public Key **CoDE** prompt is still visible on the face of the control simply push the Advance key to proceed to the Password **PRSS** prompt. If not find your way back to the Factory Page as described above.



4. Execute the calculation defined below (7b or 8b) for either the User or Administrator.
5. Enter the result of the calculation in the upper display by using the Up  or Down  arrow keys or use EZ-ZONE Configurator Software.
6. Exit the Factory Page by pushing and holding the Infinity  key for two seconds.

Formulas used by the User and the Administrator to calculate the Password follows:

Passwords equal:

#### 7. User

- a. If Rolling Password  `ROLL` is Off, Password  `PASS` equals User Password  `PASS.U`.
- b. If Rolling Password  `ROLL` is On, Password  `PASS` equals:  
 $(\text{PASS.U} \times \text{code}) \text{ Mod } 929 + 70$

#### 8. Administrator

- a. If Rolling Password  `ROLL` is Off, Password  `PASS` equals User Password  `PASS.A`.
- b. If Rolling Password  `ROLL` is On, Password  `PASS` equals:  
 $(\text{PASS.A} \times \text{code}) \text{ Mod } 997 + 1000$

### Differences Between a User Without Password, User With Password and Administrator

- User **without** a password is restricted by the Locked Access Level  `LoLL`.
- A User **with** a password is restricted by the Read Lockout Security  `rLoL` never having access to the Lock Menu  `LoL`.
- An Administrator is restricted according to the Read Lockout Security  `rLoL` however, the Administrator has access to the Lock Menu where the Read Lockout can be changed.

to) the Modbus address of a parameter within the ST control.

### Assembly Working Addresses

- Fixed addresses directly related to their associated "Assembly Definition Addresses" (i.e., Assembly Working Addresses 200 & 201 will assume the parameter pointed to by Assembly Definition Addresses 40 & 41).

When the Modbus address of a target parameter is stored in an "Assembly Definition Address" its corresponding working address will return that parameter's actual value. If it's a writable parameter, writing to its working register will change the parameter's actual value.

As an example, Modbus register 360 contains the Analog Input 1 Process Value (See Operations Page, Analog Input Menu). If the value 360 is loaded into Assembly Definition Address 91, the process value sensed by analog input 1 will also be stored in Modbus registers 250 and 251. Note that by default this parameter is also stored in working registers 240 and 241 as well.

The table (See Appendix: Modbus Programmable Memory Blocks) identified as "Assembly Definition Addresses and Assembly Working Addresses" reflects the assemblies and their associated addresses.

## Modbus - Using Programmable Memory Blocks

When using the Modbus protocol, the PM control features a block of addresses that can be configured by the user to provide direct access to a list of 40 user configured parameters. This allows the user easy access to this customized list by reading from or writing to a contiguous block of registers.

To acquire a better understanding of the tables found in the back of this manual (See Appendix: [Modbus Programmable Memory Blocks](#)) please read through the text below which defines the column headers used.

### Assembly Definition Addresses

- Fixed addresses used to define the parameter that will be stored in the "Working Addresses", which may also be referred to as a pointer. The value stored in these addresses will reflect (point

# Software Configuration

## Using EZ-ZONE® Configurator Software

To enable a user to configure the PM control using a personal computer (PC), Watlow has provided free software for your use. If you have not yet obtained a copy of this software insert the CD (Controller Support Tools) into your CD drive and install the software. Alternatively, if you are viewing this document electronically and have a connection to the internet simply click on the link below and download the software from the Watlow web site free of charge.

[http://www.watlow.com/products/software/zone\\_config.cfm](http://www.watlow.com/products/software/zone_config.cfm)

Once the software is installed double click on the EZ-ZONE Configurator icon placed on your desktop during the installation process. If you cannot find the icon follow the steps below to run the software:

1. Move your mouse to the "Start" button
2. Place the mouse over "All Programs"
3. Navigate to the "Watlow" folder and then the sub-folder "EZ-ZONE Configurator"
4. Click on EZ-ZONE Configurator to run.

The first screen that will appear is shown below.

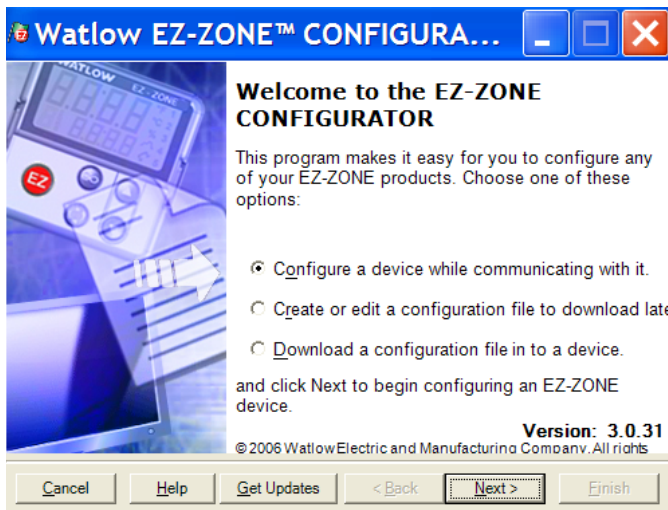

If the PC is already physically connected to the EZ-ZONE PM control click the next button to go on-line.

### Note:

When establishing communications from PC to the EZ-ZONE PM control an interface converter will be required. The Standard Bus network uses EIA-485 as the interface. Most PCs today would require a USB to EIA-485 converter. However, some PCs may still be equipped with EIA-232 ports, therefore an EIA-232 to EIA-485 converter would be required.

As can be seen in the above screen shot the software provides the user with the option of downloading a previously saved configuration as well as the ability to create a configuration off-line to download later. The screen shots that follow will take the user on-line.

After clicking the next button above it is necessary to define the communications port on the PC to use.

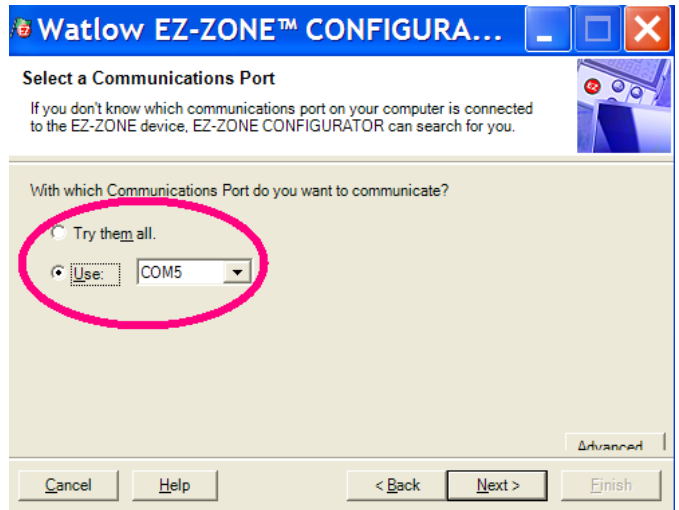

The available options allow the user to select "Try them all" or to use a specific known communications port. After installation of your converter if you are not sure which communications port was allocated select "Try them all" and then click next. The screen to follow shows that the software is scanning for devices on the network and that progress is being made.

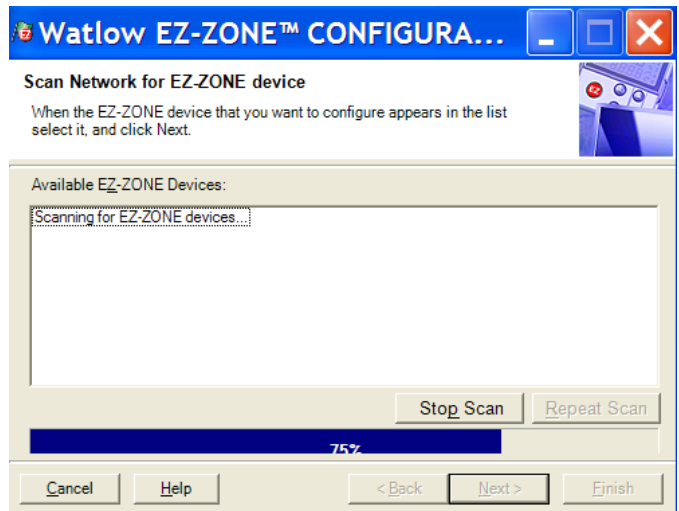

When complete the software will display all of the available devices found on the network as shown below.

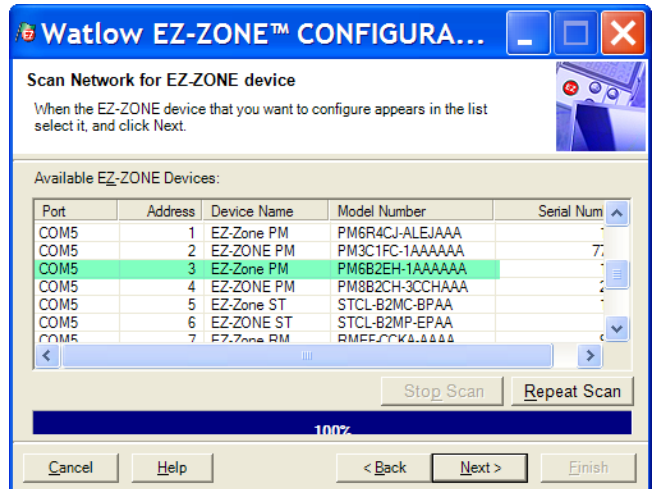

In the previous screen shot the PM is shown highlighted to bring greater clarity to the control in focus. Any EZ-ZONE device on the network will appear in this window and would be available for the purpose of configuration or monitoring. After clicking on the control of choice simply click the next button once again. The next screen appears below.

more clarity for the area of focus by not displaying unwanted menus and parameters. Once the focus is brought to an individual parameter (single click of mouse) as is the case for Analog Input 1 in the left column, all that can be setup related to that parameter will appear in the center column. The grayed out fields in the center column simply mean that this

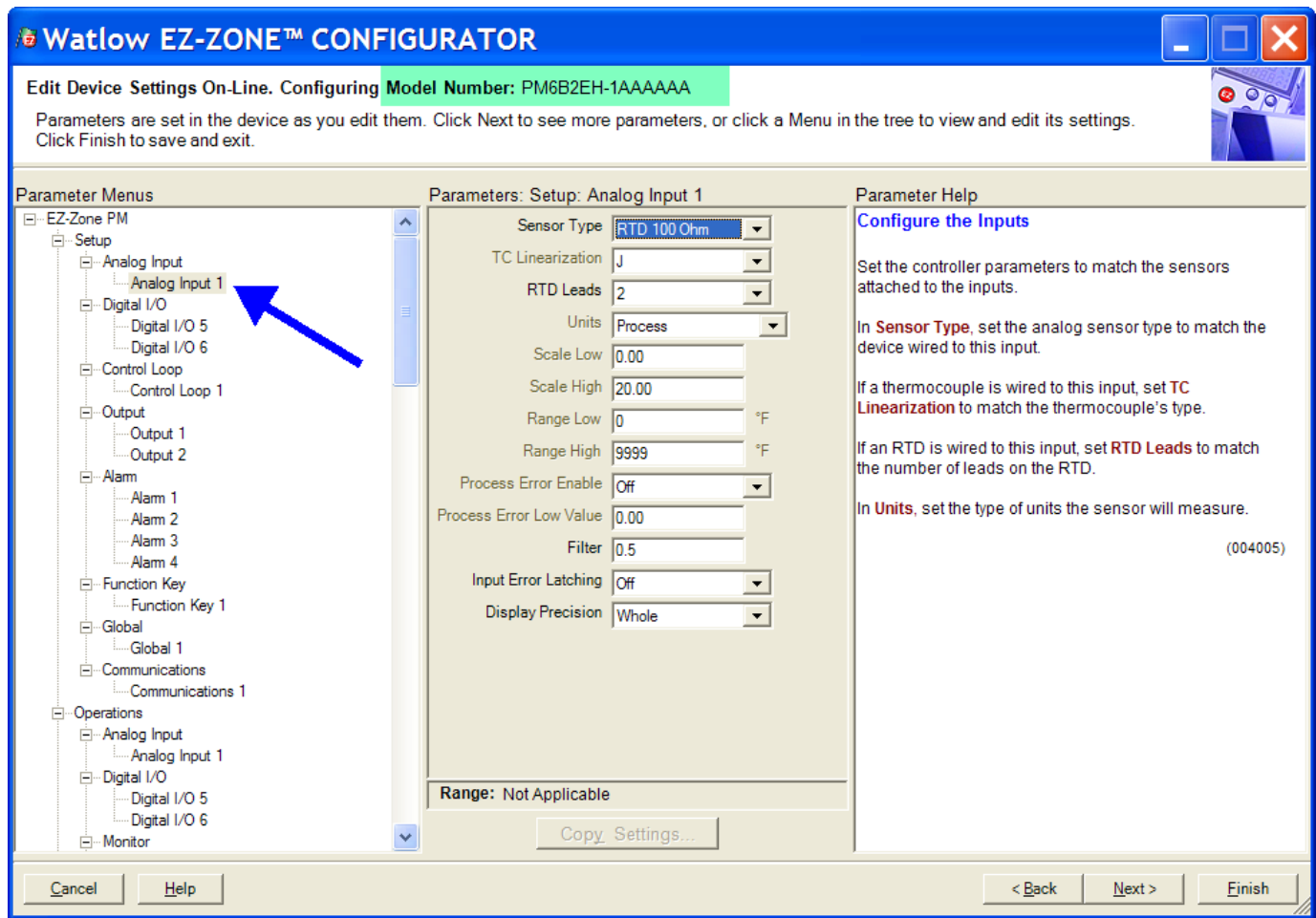

In the screen shot above notice that the device part number is clearly displayed at the top of the page (green highlight added for emphasis). When multiple EZ-ZONE devices are on the network it is important that the part number be noted prior to configuring so as to avoid making unwanted configuration changes to another control.

Looking closely at the left hand column (Parameter Menus) notice that it displays all of the available menus and associated parameters within the control. The menu structure as laid out within this software follows:

- Setup
- Operations
- Factory
- Profile

Navigating from one menu to the next is easy and clearly visible. Simply slide the scroll bar up or down to display the menu and parameter of choice. As an alternative, clicking on the negative symbol next to Setup will collapse the Setup Menu where the Operations Menu will appear next and perhaps deliver

does not apply for the type of sensor selected. As an example, notice that when RTD is selected, TC Linearization does not apply and is therefore grayed out. To speed up the process of configuration notice that at the bottom of the center column there is an option to copy settings. If Analog Input 1 and 2 are the same type of sensor click on "Copy Settings" where a copy from to copy to dialog box will appear allowing for quick duplication of all settings.

Notice too, that by clicking on any of those items in the center column that context sensitive help will appear for that particular item in the right hand column.

Lastly, when the configuration is complete click the "Finish" button at the bottom right of the previous screen shot. The screen that follows this action can be seen below.

The user can save the file to any folder of choice.

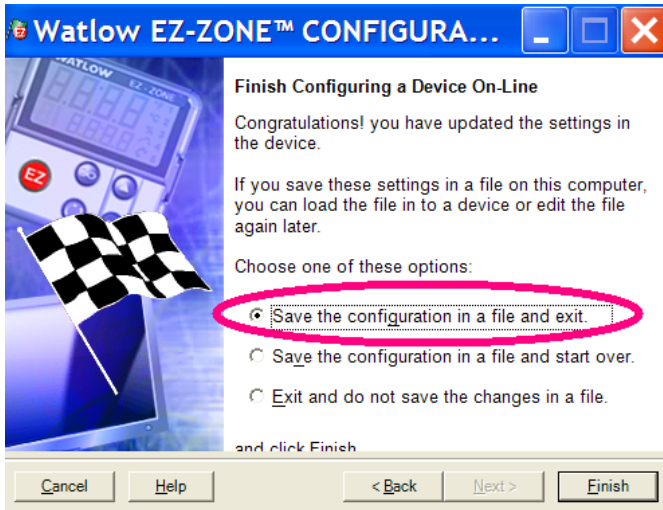

Although the PM control now contains the configuration (because the previous discussion focused on doing the configuration on-line) it is suggested that after the configuration process is completed that the user save this file on the PC for future use. If for some reason someone inadvertently changed a setting without understanding the impact it would be easy and perhaps faster to download a saved configuration back to the control versus trying to figure out what was changed.

Of course, there is an option to exit without saving a copy to the local hard drive.

After selecting Save above click the "Finish" button once again. The screen below will then appear.

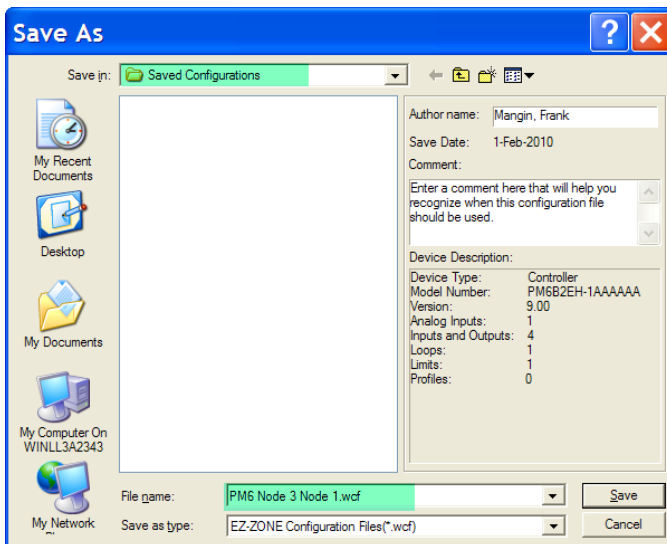





When saving the configuration note the location where the file will be placed (Saved in) and enter the file name (File name) as well. The default path for saved files follows:

\Program Files\Watlow\EZ-ZONE CONFIGURATOR\Saved Configurations

# Chapter 10: Appendix

Troubleshooting Alarms, Errors and Control Issues			
Indication	Description	Possible Causes	Corrective Action
Alarm won't clear or reset	Alarm will not clear or reset with keypad or digital input	<ul style="list-style-type: none"> <li>Alarm latching is active</li> <li>Alarm set to incorrect output</li> <li>Alarm is set to incorrect source</li> <li>Sensor input is out of alarm set point range</li> <li>Alarm set point is incorrect</li> <li>Alarm is set to incorrect type</li> <li>Digital input function is incorrect</li> </ul>	<ul style="list-style-type: none"> <li>Reset alarm when process is within range or disable latching</li> <li>Set output to correct alarm source instance</li> <li>Set alarm source to correct input instance</li> <li>Correct cause of sensor input out of alarm range</li> <li>Set alarm set point to correct trip point</li> <li>Set alarm to correct type: process, deviation or power</li> <li>Set digital input function and source instance</li> </ul>
Alarm won't occur	Alarm will not activate output	<ul style="list-style-type: none"> <li>Alarm silencing is active</li> <li>Alarm blocking is active</li> <li>Alarm is set to incorrect output</li> <li>Alarm is set to incorrect source</li> <li>Alarm set point is incorrect</li> <li>Alarm is set to incorrect type</li> </ul>	<ul style="list-style-type: none"> <li>Disable alarm silencing, if required</li> <li>Disable alarm blocking, if required</li> <li>Set output to correct alarm source instance</li> <li>Set alarm source to correct input instance</li> <li>Set alarm set point to correct trip point</li> <li>Set alarm to correct type: process, deviation or power</li> </ul>
<b>ALe1</b> Alarm Error <b>ALe2</b> <b>ALe3</b> <b>ALe4</b>	Alarm state cannot be determined due to lack of sensor input	<ul style="list-style-type: none"> <li>Sensor improperly wired or open</li> <li>Incorrect setting of sensor type</li> <li>Calibration corrupt</li> </ul>	<ul style="list-style-type: none"> <li>Correct wiring or replace sensor</li> <li>Match setting to sensor used</li> <li>Check calibration of controller</li> </ul>
<b>ALl1</b> Alarm Low <b>ALl2</b> <b>ALl3</b> <b>ALl4</b>	Sensor input below low alarm set point	<ul style="list-style-type: none"> <li>Temperature is less than alarm set point</li> <li>Alarm is set to latching and an alarm occurred in the past</li> <li>Incorrect alarm set point</li> <li>Incorrect alarm source</li> </ul>	<ul style="list-style-type: none"> <li>Check cause of under temperature</li> <li>Clear latched alarm</li> <li>Establish correct alarm set point</li> <li>Set alarm source to proper setting</li> </ul>
<b>ALh1</b> Alarm High <b>ALh2</b> <b>ALh3</b> <b>ALh4</b>	Sensor input above high alarm set point	<ul style="list-style-type: none"> <li>Temperature is greater than alarm set point</li> <li>Alarm is set to latching and an alarm occurred in the past</li> <li>Incorrect alarm set point</li> <li>Incorrect alarm source</li> </ul>	<ul style="list-style-type: none"> <li>Check cause of over temperature</li> <li>Clear latched alarm</li> <li>Establish correct alarm set point</li> <li>Set alarm source to proper setting</li> </ul>
<b>Er..1</b> Error Input	Sensor does not provide a valid signal to controller	<ul style="list-style-type: none"> <li>Sensor improperly wired or open</li> <li>Incorrect setting of sensor type</li> <li>Calibration corrupt</li> </ul>	<ul style="list-style-type: none"> <li>Correct wiring or replace sensor</li> <li>Match setting to sensor used</li> <li>Check calibration of controller</li> </ul>
Indication	Description	Possible Causes	Corrective Action

<p><b>[LPoI]</b> Loop Open Error</p>	<p>Open Loop Detect is active and the process value did not deviate by a user-selected value in a user specified period.</p>	<ul style="list-style-type: none"> <li>• Setting of Open Loop Detect Time incorrect</li> <li>• Setting of Open Loop Detect Deviation incorrect</li> <li>• Thermal loop is open</li> <li>• Open Loop Detect function not required but activated</li> </ul>	<ul style="list-style-type: none"> <li>• Set correct Open Loop Detect Time for application</li> <li>• Set correct Open Loop Deviation value for application</li> <li>• Determine cause of open thermal loop: misplaced sensors, load failure, loss of power to load, etc.</li> <li>• Deactivate Open Loop Detect feature</li> </ul>
<p><b>[LPri]</b> Loop Reversed Error</p>	<p>Open Loop Detect is active and the process value is headed in the wrong direction when the output is activated based on deviation value and user-selected value.</p>	<ul style="list-style-type: none"> <li>• Setting of Open Loop Detect Time incorrect</li> <li>• Setting of Open Loop Detect Deviation incorrect</li> <li>• Output programmed for incorrect function</li> <li>• Thermocouple sensor wired in reverse polarity</li> </ul>	<ul style="list-style-type: none"> <li>• Set correct Open Loop Detect Time for application</li> <li>• Set correct Open Loop Deviation value for application</li> <li>• Set output function correctly</li> <li>• Wire thermocouple correctly, (red wire is negative)</li> </ul>
<p><b>[rPI]</b> Ramping 1</p>	<p>Controller is ramping to new set point</p>	<ul style="list-style-type: none"> <li>• Ramping feature is activated</li> </ul>	<ul style="list-style-type: none"> <li>• Disable ramping feature if not required</li> </ul>
<p><b>[AUT1]</b> Autotuning 1</p>	<p>Controller is autotuning the control loop</p>	<ul style="list-style-type: none"> <li>• User started the autotune function</li> <li>• Digital input is set to start autotune</li> </ul>	<ul style="list-style-type: none"> <li>• Wait until autotune completes or disable autotune feature</li> <li>• Set digital input to function other than autotune, if desired</li> </ul>
<p>No heat/cool action</p>	<p>Output does not activate load</p>	<ul style="list-style-type: none"> <li>• Output function is incorrectly set</li> <li>• Control mode is incorrectly set</li> <li>• Output is incorrectly wired</li> <li>• Load, power or fuse is open</li> <li>• Control set point is incorrect</li> <li>• Incorrect controller model for application</li> </ul>	<ul style="list-style-type: none"> <li>• Set output function correctly</li> <li>• Set control mode appropriately (Open vs Closed Loop)</li> <li>• Correct output wiring</li> <li>• Correct fault in system</li> <li>• Set control set point in appropriate control mode and check source of set point: remote, idle, profile, closed loop, open loop</li> <li>• Obtain correct controller model for application</li> </ul>
<p>No Display</p>	<p>No display indication or LED illumination</p>	<ul style="list-style-type: none"> <li>• Power to controller is off</li> <li>• Fuse open</li> <li>• Breaker tripped</li> <li>• Safety interlock switch open</li> <li>• Separate system limit control activated</li> <li>• Wiring error</li> <li>• Incorrect voltage to controller</li> </ul>	<ul style="list-style-type: none"> <li>• Turn on power</li> <li>• Replace fuse</li> <li>• Reset breaker</li> <li>• Close interlock switch</li> <li>• Reset limit</li> <li>• Correct wiring issue</li> <li>• Apply correct voltage, check part number</li> </ul>
<p>No Serial Communication</p>	<p>Cannot establish serial communications with the controller</p>	<ul style="list-style-type: none"> <li>• Address parameter incorrect</li> <li>• Incorrect protocol selected</li> <li>• Baud rate incorrect</li> <li>• Parity incorrect</li> <li>• Wiring error</li> <li>• EIA-485 converter issue</li> <li>• Incorrect computer or PLC communications port</li> <li>• Incorrect software setup</li> <li>• Termination resistor may be required</li> </ul>	<ul style="list-style-type: none"> <li>• Set unique addresses on network</li> <li>• Match protocol between devices</li> <li>• Match baud rate between devices</li> <li>• Match parity between devices</li> <li>• Correct wiring issue</li> <li>• Check settings or replace converter</li> <li>• Set correct communication port</li> <li>• Correct software setup to match controller</li> <li>• Place 120 Ω resistor across EIA-485 on last controller</li> </ul>

Indication	Description	Possible Causes	Corrective Action
Process doesn't control to set point	Process is unstable or never reaches set point	<ul style="list-style-type: none"> <li>• Controller not tuned correctly</li> <li>• Control mode is incorrectly set</li> <li>• Control set point is incorrect</li> </ul>	<ul style="list-style-type: none"> <li>• Perform autotune or manually tune system</li> <li>• Set control mode appropriately (Open vs Closed Loop)</li> <li>• Set control set point in appropriate control mode and check source of set point: remote, idle, profile, closed loop, open loop</li> </ul>
Temperature runaway	Process value continues to increase or decrease past set point.	<ul style="list-style-type: none"> <li>• Controller output incorrectly programmed</li> <li>• Thermocouple reverse wired</li> <li>• Controller output wired incorrectly</li> <li>• Short in heater</li> <li>• Power controller connection to controller defective</li> <li>• Controller output defective</li> </ul>	<ul style="list-style-type: none"> <li>• Verify output function is correct (heat or cool)</li> <li>• Correct sensor wiring (red wire negative)</li> <li>• Verify and correct wiring</li> <li>• Replace heater</li> <li>• Replace or repair power controller</li> <li>• Replace or repair controller</li> </ul>
 Device Error	Controller displays internal malfunction message at power up.	<ul style="list-style-type: none"> <li>• Controller defective</li> </ul>	<ul style="list-style-type: none"> <li>• Replace or repair controller</li> </ul>
Menus inaccessible	Unable to access  ,  ,  or  menus or particular prompts in Home Page	<ul style="list-style-type: none"> <li>• Security set to incorrect level</li> <li>• Digital input set to lockout keypad</li> <li>• Custom parameters incorrect</li> </ul>	<ul style="list-style-type: none"> <li>• Check lockout setting in Factory Page</li> <li>• Change state of digital input</li> <li>• Change custom parameters in Factory Page</li> </ul>
EZ-Key doesn't work	EZ-Key does not activate required function	<ul style="list-style-type: none"> <li>• EZ-Key function incorrect</li> <li>• EZ-Key function instance not correct</li> <li>• Keypad malfunction</li> </ul>	<ul style="list-style-type: none"> <li>• Verify EZ-Key function in Setup Menu</li> <li>• Check that the function instance is correct</li> <li>• Replace or repair controller</li> </ul>

# Modbus - Programmable Memory Blocks

## Assembly Definition Addresses and Assembly Working Addresses

Assembly Definition Addresses	Assembly Working Addresses	Assembly Definition Addresses	Assembly Working Addresses
40 & 41	200 & 201	80 & 81	240 & 241
42 & 43	202 & 203	82 & 83	242 & 243
44 & 45	204 & 205	84 & 85	244 & 245
46 & 47	206 & 207	86 & 87	246 & 247
48 & 49	208 & 209	88 & 89	248 & 249
50 & 51	210 & 211	90 & 91	250 & 251
52 & 53	212 & 213	92 & 93	252 & 253
54 & 55	214 & 215	94 & 95	254 & 255
56 & 57	216 & 217	96 & 97	256 & 257
58 & 59	218 & 219	98 & 99	258 & 259
60 & 61	220 & 221	100 & 101	260 & 261
62 & 63	222 & 223	102 & 103	262 & 263
64 & 65	224 & 225	104 & 105	264 & 265
66 & 67	226 & 227	106 & 107	266 & 267
68 & 69	228 & 229	108 & 109	268 & 269
70 & 71	230 & 231	110 & 111	270 & 271
72 & 73	232 & 233	112 & 113	272 & 273
74 & 75	234 & 235	114 & 115	274 & 275
76 & 77	236 & 237	116 & 117	276 & 277
78 & 79	238 & 239	118 & 119	278 & 279

### Assembly Definition Addresses Default Pointers

### Assembly Working Addresses

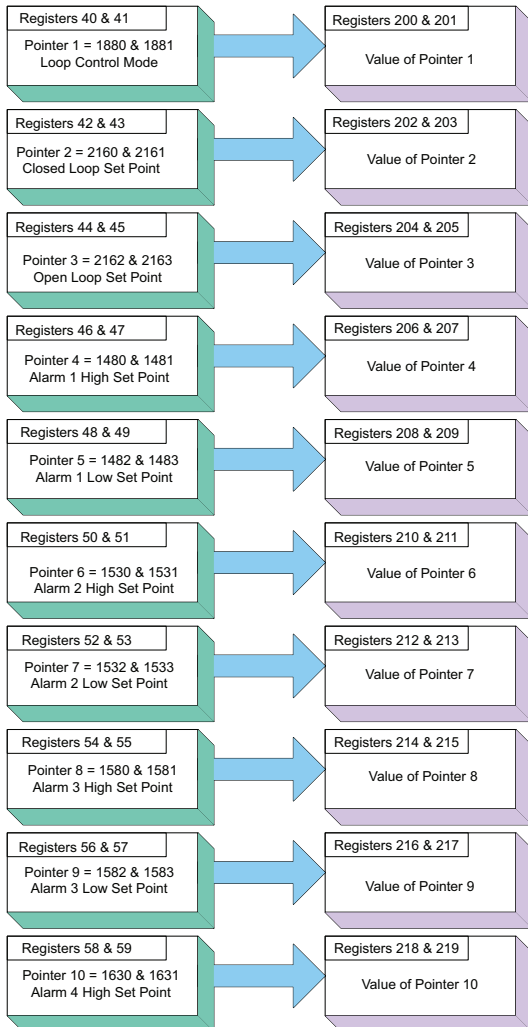

### Assembly Definition Addresses Default Pointers

### Assembly Working Addresses

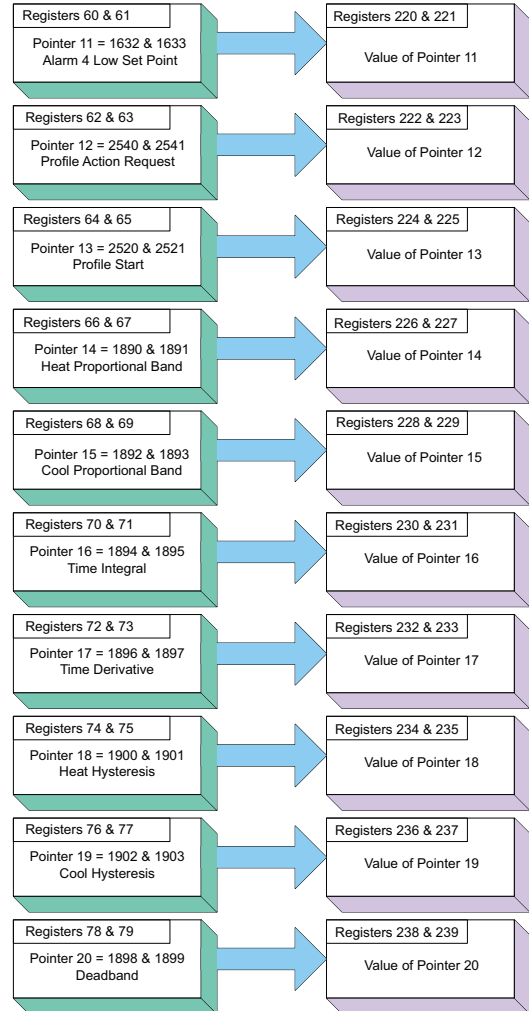



# Modbus Default Assembly Structure 80-119

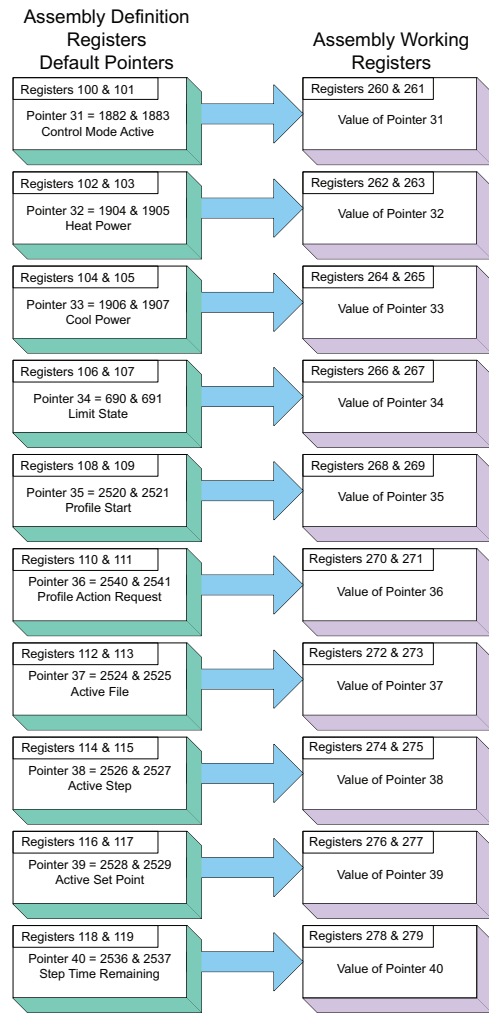
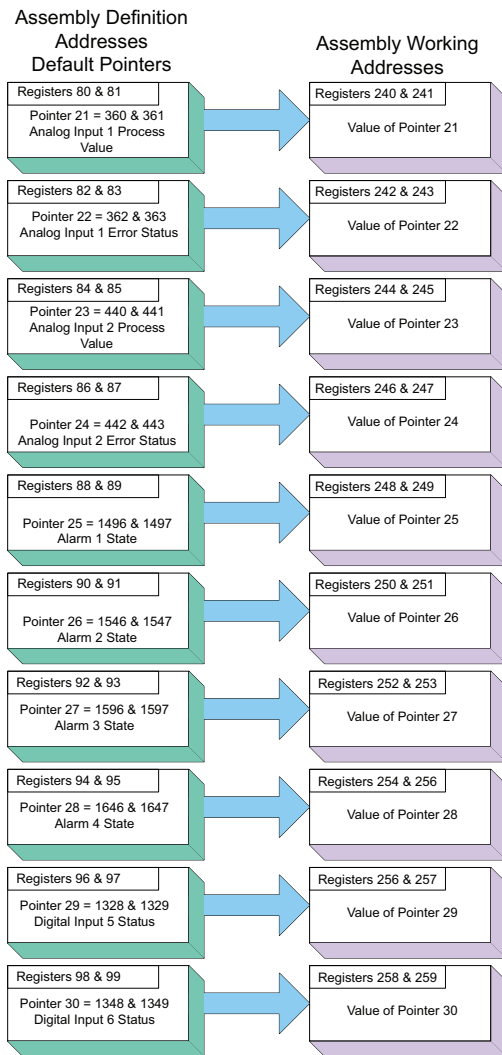

# Specifications

## LineVoltage/Power (Minimum /Maximum Ratings)

- 85 to 264V~ (ac), 47 to 63Hz
- 20 to 28V~ (ac), 47 to 63Hz
- 12 to 40V= (dc)
- 14VA maximum power consumption (PM4, 8 & 9)
- 10VAm maximum power consumption (PM3 & 6)
- Data retention upon power failure via nonvolatile memory
- Compliant with SEMIF47-0200, FigureR1-1 voltage sag requirements @24V ~ (ac) or higher

## Environment

- 0 to 149°F (-18 to 65°C) operating temperature
- 40 to 185°F (-40 to 85°C) storage temperature
- 0 to 90%RH, non-condensing

## Accuracy

- Calibration accuracy and sensor conformity: ±0.1% of span, ±1°C @ the calibrated ambient temperature and rated line voltage
- Types R, S, B; 0.2%
- Type T below -50°C; 0.2%
- Calibration ambient temperature @ 77 ±5°F (25±3°C)
- Accuracy span :1000 °F (540°C) min.
- Temperature stability: ±0.1 °F/°F (±0.1 °C/°C) rise in ambient maximum

## Agency Approvals

- UL® Listed to UL® 61010-1 File E185611
- UL® Reviewed to CSA C22.2 No.61010-1-04
- UL® 50 Type 4X, NEMA 4X indoor locations, IP66 front panel seal (indoor use only)
- FM Class 3545 File 3029084 temperature limit switches
- CE-See Declaration of Conformity RoHS and W.E.E.E.compliant
- This equipment is suitable for use in Class 1, Div.2, Groups A, B, C and D or non-hazardous locations only. Temperature Code T4A
- UL® Listed to ANSI/ISA 12.12.01-2007 File E184390
- PM3/6 CSA C22. No. 24 File 158031 Class 4813-02, both 1/32 and 1/16 DIN CSA approved
- UL® reviewed to Standard No. CSA C22.2 No.213-M1987, Canadian Hazardous locations

## Controller

- User selectable heat/cool, on-off, P, PI, PD, PID or alarm action
- Auto-tune with TRU-TUNE®+ adaptive control algorithm
- Control sampling rates: input = 10Hz, outputs = 10Hz

## Profile Ramp/Soak - Real Time Clock and Battery Back-up

- Accuracy (typical): ±30PPM at 77°F (25°C)
- +30/-100 PPM at -4 to 149°F (-20 to 65°C)
- Battery type: lithium (recycle properly)
- Battery typical life: three cumulative years of unpowered life at 77°F (25°C)

## Isolated Serial Communications

- EIA232/485, Modbus® RTU

## Wiring Termination—Touch-Safe Terminals

- Input, power and controller output terminals are touch safe removable 3.30 to 0.0507 mm<sup>2</sup> (12 to 22 AWG)
- Wire strip length 7.6 mm (0.30 in.)
- Torque 0.8 Nm (7.0 lb.-in.)

## Universal Input

- Thermocouple, grounded or ungrounded sensors
- >20MΩ input impedance
- 3μA open sensor detection
- Max. of 2KΩ source resistance
- RTD 2 or 3 wire, platinum, 100Ω and 1000Ω @ 0°C calibration to DIN curve (0.00385Ω/Ω/°C)
- Process, 0-20mA @ 100Ω ,or 0-10V =(dc) @ 20kΩ input imped-

ance

## Voltage Input Ranges

- Accuracy ±10mV ±1 LSD at standard conditions
- Temperature stability ±100 PPM/°C maximum

## Milliamp Input Ranges

- Accuracy ±20μA ±1 LSD at standard conditions
- Temperature stability ±100 PPM/°C maximum

## Resolution Input Ranges

- 0 to 10V: 200 μV nominal
- 0 to 20 mA: 0.5 mA nominal

- Potentiometer: 0 to 1,200Ω

- Inverse scaling

Input Type	Max Error @ 25 Deg C	Accuracy Range Low	Accuracy Range High	Units
J	±1.75	0	750	Deg C
K	±2.45	-200	1250	Deg C
T (-200 to 350)	±1.55	0	350	Deg C
N	±2.25	0	1250	Deg C
E	±2.10	-200	900	Deg C
R	±3.9	0	1450	Deg C
S	±3.9	0	1450	Deg C
B	±2.66	870	1700	Deg C
C	±3.32	0	2315	Deg C
D	±3.32	0	2315	Deg C
F (PTII)	±2.34	0	1343	Deg C
RTD, 100 ohm	±2.00	-200	800	Deg C
RTD, 1000 ohm	±2.00	-200	800	Deg C
mV	±0.05	0	50	mV
Volts	±0.01	0	10	Volts
mAdc	±0.02	0	20	mAmps DC
mAac	±5	-50	50	mAmps AC
Potentiometer, 1K range	±1	0	1000	Ohms
Thermistor, 5K range	±5	0	5000	Ohms
Thermistor, 10K range	±10	0	10000	Ohms
Thermistor, Thermistor	±20	0	20000	Ohms
Thermistor, 40K range	±40	0	40000	Ohms

Operating Range		
Input Type	Range Low	Range High
J	-210	1200
K	-270	1371
T	-270	400
N	-270	1300
E	-270	1000
R	-50	1767

Operating Range		
S	-50	1767
B	-50	1816
C	0	2315
D	0	2315
F (PTII)	0	1343
RTD (100 ohm)	-200	800
RTD (1000 ohm)	-200	800
mV	-50	50
Volts	0	10
mAdc	0	20
mAac	-50	50
Potentiometer, 1K range	0	1200
Resistance, 5K range	0	5000
Resistance, 10K range	0	10000
Resistance, 20K range	0	20000
Resistance, 40K range	0	40000

### Thermistor Input

- 0 to 40K $\Omega$ , 0 to 20K $\Omega$ , 0 to 10K $\Omega$ , 0 to 5K $\Omega$
- 2.252K $\Omega$  and 10K $\Omega$  base at 77°F (25°C)
- Linearization curves built in
- Third party Thermistor compatibility requirements

Base R @ 25C	Alpha Techniques	Beta THERM	YSI	Prompt
2.252K	Curve A	2.2K3A	004	A 
10K	Curve A	10K3A	016	B
10K	Curve C	10K4A	006	C

### 2 Digital Input/Output Option - 2 DIO

- Digital input update rate 10Hz
  - DC voltage
    - Max. input 36V @ 3mA
    - Min. high state 3V at 0.25mA
    - Max. low state 2V
  - Dry contact
    - Min. open resistance 10K $\Omega$
    - Max. closed resistance 50 $\Omega$
    - Max. short circuit 20mA
- Digital output update rate 10Hz
  - Output voltage 24V, current limit, Output 6 = 10mA max., Output 5 = 3 pole DIN-A-MITE<sup>®</sup> or 24mA max.

### Output Hardware

- Switched dc = 22 to 32V $\approx$  (dc) @ 30mA
- Switched dc/open collector = 30V $\approx$  (dc) max. @ 100mA max. current sink
- Solid state relay (SSR), FormA, 0.5A @ 24V $\sim$  (ac) min., 264V $\sim$  (ac) max., opto-isolated, without contact suppression, 20 VA 120/240V $\sim$  (ac) pilot duty
- Electromechanical relay, FormC, 5A, 24 to 240V $\sim$  (ac) or 30V $\approx$  (dc) max., resistive load, 100,000 cycles at rated load, 125 VA pilot duty at 120/240V $\sim$  (ac), 25 VA at 24V $\sim$  (ac)
- Electromechanical relay, FormA, 5A, 24 to 240V $\sim$  (ac) or 30V $\approx$  (dc) max., resistive load, 100,000 cycles at rated load, 125 VA pilot duty at 120/240V $\sim$  (ac), 25 VA at 24V $\sim$  (ac)
- NO-ARC relay, FormA, 15A, 24 to 240V $\sim$  (ac), noV $\approx$  (dc), resistive load, 2 million cycles at rated load
- Universal process/retransmit, Output range selectable:
  - 0 to 10V $\approx$ (dc) into a min. 1,000 $\Omega$  load

- 0 to 20mA into max. 800 $\Omega$  load

#### Resolution

- dc ranges: 2.5mV nominal
- mA ranges: 5  $\mu$ A nominal

#### Calibration Accuracy

- dc ranges:  $\pm$ 15 mV
- mA ranges:  $\pm$ 30  $\mu$ A

#### Temperature Stability

- 100 ppm/ $^{\circ}$ C

### Operator Interface

- Dual 4 digit, 7 segment LED displays
- Advance, infinity, up and down keys, plus optional programmable EZ-KEY(s) depending on model size
- Typical display update rate 1Hz
- RESET key substituted for infinity on all models including the limit control

### Dimensions

Dimensions				
Size	Behind Panel (max.)	Width	Height	Display Character Height
1/32	101.6 mm (4.00 in)	53.3 mm (2.10 in)	30.9 mm (1.22 in)	left: 7.59 mm (0.299 in) right: 5.90 mm (0.220 in)
1/4	100.8 mm (3.97 in)	100.3 mm (3.95 in)	100.3 mm (3.95 in)	up: 11.43 mm (0.450 in) middle: 9.53 mm (0.375 in) low: 7.62 mm (0.300 in)
1/16	101.6 mm (4.00 in)	53.3 mm (2.10 in)	53.3 mm (2.10 in)	up: 10.80 mm (0.425 in) low: 6.98 mm (0.275 in)
1/8 (H)	101.6 mm (4.00 in)	100.3 mm (2.10 in)	53.9 mm (1.22 in)	top: 11.4 mm (0.450 in) middle: 9.53 mm (0.375 in) bottom: 7.62 mm (0.300 in)
1/8 (V)	101.6 mm (4.00 in)	53.3 mm (2.10 in)	100.3 mm (3.95 in)	top: 11.4 mm (0.450 in) middle: 9.53 mm (0.375 in) bottom: 7.62 mm (0.300 in)

### Weight

1/32 DIN (PM3)	1/8 DIN (PM8&9)
• Controller: 127 g (4.5 oz.)	• Controller: 284 g (10 oz.)
1/16 DIN (PM6)	1/4 DIN (PM4)
• Controller: 186 g (6.6 oz.)	• Controller: 331 g (11.7 oz.)
User Manual	
• User manual: 221.81 g (7.82 oz)	

Modbus<sup>®</sup> is a trademark of AEG Schneider Automation Inc.

EtherNet/IP<sup>™</sup> is a trademark of ControlNet International Ltd. used under license by Open DeviceNet Vendor Association, Inc. (ODVA).

UL<sup>®</sup> is a registered trademark of Underwriters Laboratories Inc.

DeviceNet<sup>™</sup> is a trademark of Open DeviceNet Vendors Association.

### Note:

These specifications are subject to change without prior notice.

# Ordering Information for PID Controller Models

## Controller

EZ-ZONE® PID Controller Models  
 TRU-TUNE+® Adaptive Tune, red-green 7-segment displays

P M - A A A A

## Package Size

- 3 Panel Mount 1/32 DIN
- 6 Panel Mount 1/16 DIN
- 8 Panel Mount 1/8 DIN Vertical
- 9 Panel Mount 1/8 DIN Horizontal
- 4 Panel Mount 1/4 DIN Horizontal

## Primary Function

- C PID Controller with Universal Input
- R PID Controller with Universal Input and Profiling Ramp and Soak
- B PID Controller with Universal Input and Profiling Ramp and Soak and Battery Backup with Real Time Clock
- J PID Controller with Thermistor Input
- N PID Controller with Thermistor Input and Profiling Ramp and Soak
- E PID Controller with Thermistor Input and Profiling Ramp and Soak and Battery Backup with Real Time Clock
- S Custom Firmware

- Options B and E are not available with PM3 or PM6

## Power Supply, Digital Input/Output

- 1 100 to 240V~ (ac)
- 2 100 to 240V~ (ac) plus 2 Digital I/O points
- 3 15 to 36V= (dc) and 24V~ (ac)
- 4 15 to 36V= (dc) and 24V~ (ac), plus 2 Digital I/O points

## Output 1 and 2 Hardware Options

Output 1		Output 2
CA	Switched dc/open collector	None
CH	Switched dc/open collector	NO-ARC 15 A power control
CC	Switched dc/open collector	Switched dc
CJ	Switched dc/open collector	Mechanical relay 5 A, form A
CK	Switched dc/open collector	Solid-State Relay 0.5 A, form A
EA	Mechanical relay 5 A, form C	None
EH	Mechanical relay 5 A, form C	NO-ARC 15 A power control
EC	Mechanical relay 5 A, form C	Switched dc
EJ	Mechanical relay 5 A, form C	Mechanical relay 5 A, form A
EK	Mechanical relay 5 A, form C	Solid-State Relay 0.5 A, form A
FA	Universal process	None
FC	Universal process	Switched dc (cannot use variable time base)
FJ	Universal process	Mechanical relay 5 A, form A (cannot use variable time base)
FK	Universal process	Solid-State Relay 0.5 A, form A (cannot use variable time base)
AK	None	Solid-State Relay 0.5 A, form A
KH	Solid-State Relay 0.5 A, form A	NO-ARC 15 A power control
KK	Solid-State Relay 0.5 A, form A	Solid-state relay 0.5 A, form A

- Options CH, EH and KH are not available with PM3 (1/32 DIN)

## Communications Options

- A None
- 1 EIA 485 Modbus RTU®

- Standard Bus EIA-485 always included - all models

## Future Options

- AAAA None

## Custom Options

- AA Standard EZ-ZONE face plate
- 12 Class 1, Div. 2 (Not available with mechanical relay output types E, H, J)

# Index

- AbL** Alarm Blocking 58, 83
- ACLF** AC Line Frequency 60, 82
- AdL** Alarm Delay 59
- AdSP** Alarm Display 59
- Ah** Alarm High Set Point 39, 83
- AHy** Alarm Hysteresis 58, 83
- A** Analog Input Menu 34, 45
- ALA** Alarm Latching 58, 83
- ALe1 ALe2 ALe3 ALe4** Alarm Error 1 to 4 27
- AL9** Alarm Logic 58
- ALh1 ALh2 ALh3 ALh4** Alarm High 1 to 4 27
- ALh1 ALh2 ALh3 ALh4** Alarm High 1 to 4 27
- ALL1 ALL2 ALL3 ALL4** Alarm Low 1 to 4 27
- ALL1 ALL2 ALL3 ALL4** Alarm Low 1 to 4 27
- ALL1 ALL2 ALL3 ALL4** Alarm Low 1 to 4 27
- ALP7** Alarm Menu 39, 57
- ALo** Alarm Low Set Point 39, 83
- ASd** Alarm Sides 58
- AS** Alarm Silencing 59, 83
- ATP** Absolute Temperature 47
- ATSP** Autotune Set Point 37, 74
- Attn** Attention 27, 28, 83
- ATy** Alarm Type 57, 82
- AutnE** Altitude Units 49
- AUT** Autotune 37, 74
- bPLS** 79
- CA9** Cool Algorithm 52, 80
- CAL** Calibration Menu 71
- CCr** Cool Output Curve 52, 79
- C\_F** Display Units 60
- ChAn** Channel 62
- Chy** Cool Hysteresis 38, 80
- CLEd** Communications LED Activity 61
- CLoC** Wait for Time 65
- CLr** Clear 83
- CP7** Control Mode 37, 79
- CP7A** Control Mode Active 36
- Code** Public Key 68, 71
- CoP7** Communications Menu 62, 63, 65, 69
- CPb** Cool Proportional Band 38, 75, 80
- CPr** Cool Power 36, 75
- CSP** Closed Loop Set Point 37
- CSP** Closed Loop Working Set Point 36
- CUSE** Custom Menu 28, 74
- DATE** Date of Manufacture 71
- db** Dead Band 38, 81
- DEC** Decimal 46
- diO** Digital Input/Output Menu 36, 49
- dir** Direction 49
- doS** Digital Output State 36
- doWd** Day of Week 63
- dPrS** Display Pairs 44, 62
- dt** Display Time 62
- EIS** Event Input Status 36
- ELo** Electrical Input Offset 72, 76
- ELIS** Electrical Input Slope 72, 76
- ELoO** Electrical Output Offset 72
- Ent1** Active Event Output 1 41, 42
- Ent2** Event Output 2 67
- Er.1 Er.2** Error Input 1 or 2 27
- Er.1** Error Input 1 27
- FAIL** Input Error Failure 53, 79
- F** Digital Output Function Instance 50, 52
- F** Output Function Instance 55, 56
- FiL** Filter 46
- FiL** Filter Time 77
- Fn** Output Function 55, 56
- Fn** Function 48
- FUn** Function Key Menu 59
- GLbL** Global Menu 60
- 95d** Guaranteed Soak Deviation 61
- 95d1** Guaranteed Soak Deviation 1 61
- 95E** Guaranteed Soak Enable 61
- 95E** Guaranteed Soak Enable 61
- hA9** Heat Algorithm 52, 80
- hHy** Heat Hysteresis 37, 80
- hour** 33
- hoUr** 63
- hoUr** Hours 41
- hoUr** Hours Remaining 33
- hoUr** Minutes Remaining 33
- hoUr** Seconds Remaining 33
- hoUr** Hours 63
- hPb** Heat Proportional Band 37, 75, 80
- hPr** Heat Power 36, 75
- oCA** Calibration Offset 34, 76–77
- idS** Idle Set Point 37
- IEr** Input Error Latching 46
- IEr** Input Error Status 34
- IP.1** Input Point 1 47
- IP.2** Input Point 2 47
- IP.3** Input Point 3 47
- IP.4** Input Point 4 47
- IP.2** Input Point 2 47
- IP.3** Input Point 3 47
- IP.4** Input Point 4 47
- IP.5** Input Point 5 47
- IP.6** Input Point 6 48
- IP.7** Input Point 7 48
- IP.8** Input Point 8 48
- IP.9** Input Point 9 48
- IP.10** Input Point 10 48
- IPF4** IP Fixed Address Part 4 61, 62
- JC** Jump Count Remaining 42
- JS** Jump Step 66
- Ldd** Open Loop Detect Deviation 54
- LdE** Open Loop Detect Enable 53
- Ldt** Open Loop Detect Time 53
- Lin** Linearization 45
- Lnr** Linearization Menu 34, 46
- LoC** Security Setting Menu 69, 71
- LoCL** Locked Access Level 85
- LoCL** Locked Access Level 68, 70
- LoCo** Lock Operations Page 69, 84
- LoCP** Lock Profiling Page 70, 71, 84
- Loop** Control Loop Menu 52
- Loop** Loop Menu 37
- LP.o1** Loop Open Error 27
- LP.o1** Loop Open Error 1 27
- LP.r1** Loop Reversed Error 27
- LP.r1** Loop Reversed Error 1 27
- P7An** 79
- P7An** Manual Power 53
- P7AP** Data Map 32
- P7.in** 33
- P7.in** Minutes 41
- P7.in** Minutes 63
- P7on** Monitor Menu 36
- P7u** Electrical Measurement 71, 76
- nUS** Non-volatile Save 63
- nUS** Non-volatile Save 63
- oCA** Calibration Offset 57
- oCE** Output Control 50, 55
- oFn** Output Function 75, 78
- oFSE** PV Offset 35
- oh** Output High Power Scale 50, 56
- oLo** Output Low Power Scale 50, 55
- oP** Open Loop Set Point 38
- oP.2** Output Point 2 47
- oP.3** Output Point 3 47

**oP.4** Output Point 4 47  
**oP.5** Output Point 5 47  
**oP.6** Output Point 6 48  
**oP.7** Output Point 7 48  
**oP.8** Output Point 8 48  
**oP.9** Output Point 9 48  
**oP.10** Output Point 10 48  
**o.t.b** Output Time Base 50, 55  
**o.t.P.t** Output Menu 55  
**o.t.Y** Output Type 56, 78  
**P.A.S.A.**, Administrator Password 85  
**P.A.S.A.** Administrator Password 68, 70  
**P.A.S.E** Password Enable 68, 70  
**P.A.S.S** Password 71  
**P.A.S.S** Password 68  
**P.A.S.u.**, User Password 85  
**P.A.S.u.** User Password 68, 70  
**P.d.L** Peltier Delay 53  
**P.E.E** Process Error Enable 46  
**P.E.L** Process Error Low 46  
**P.n** Part Number 71  
**P.o.t.i.** Power Out Time 44  
**P.r.o** Process 47  
**P.S.t.A** Profile Status Menu 40  
**P.t.Y.P** Profile Type 61  
**P.u.n.t** Pressure Units 49  
**P.u** Process Value Menu 48  
**P.u.A** Process Value Active 36  
**r.e.n** Remote Enable 37  
**r.e.u** Software Revision 71  
**r.h.i** Range High 46, 57, 77  
**r.h** Relative Humidity 47  
**r.l.o** Range Low 45, 56, 77  
**r.L.o.C** Read Lockout Security 70, 84  
**r.o.L.L.**, Rolling Password 85  
**r.o.L.L** Rolling Password 68, 70  
**r.P** Ramp Action 54, 82  
**r.P.1** Ramping 27  
**r.P.1** Ramping 1 27  
**r.P.1** **r.P.2** Ramping 1 or 2 27  
**r.r.t** Ramp Rate 54, 82  
**r.r** Thermistor Resistance Range 46  
**r.S.C** Ramp Scale 54, 82  
**r.S.r** Retransmit Source 78  
**r.t.L** RTD Leads 45  
**r.t.P** Relative Temperature 47  
**r.t.Y.P** Ramping Type 61  
**S.b.L.d** Software Build 71  
**S.E.C** 33  
**S.E.C** Seconds 41  
**S.E.n** Sensor Type 45, 75, 77  
**S.F.n.A** Source Function A 57  
**S.h.i** Scale High 45, 56, 77, 78  
**S.i.A** Event Input Source Instance A 61  
**S.i.b** Event Input Source Instance

## B 61

**S.i.L** Silence 83  
**S.L.o** Scale Low 45, 56, 77, 78  
**S.L.o.C** Set Lockout Security 70, 84  
**S.n** Serial Number 71  
**S.S.t.P** Profile Start Step 51  
**S.t.P** Active Step 41  
**S.t.Y.P** Active Step Type 41  
**S.u.A** Source Value A 35  
**t.A.g.r** User Tune Aggressiveness 52, 74  
**t.b.n.d** TRU-TUNE+™ Band 52, 75  
**t.C** Thermistor Curve 46  
**t.d** Time Derivative 38, 75, 81  
**t.g.n** TRU-TUNE+™ Gain 52, 75  
**t.i** Time Integral 38, 75, 80  
**t.t.U.n** TRU-TUNE+™ Enable 52, 75  
**t.U.n.1** Tuning 27  
**t.U.n.1** **t.U.n.2** Tuning 1 or 2 27  
**t.U.n.1** Tuning 1 27  
**U.F.A** User Failure Action 53  
**U.L.o.C** Unlock Menu 85  
**U.S.r.r** User Restore Set 62, 74  
**U.S.r.S** User Save Set 62, 74  
**W.J.E.2** Wait Event 2 66  
**Z.o.n.E** Zone 61

## A

Absolute Temperature 47  
 AC Line Frequency 60, 82  
 A Conceptual View of the PM 4  
 Active Event Output (1 or 2) 41, 42  
 Active Step 41  
 Active Step Type 41  
 adaptive tuning 75  
 Address Modbus 62  
 Address Standard Bus 62, 63  
 Administrator Password 68, 70  
 agency approvals 3  
 alarm blocking 83  
 Alarm Menu 39, 57  
 alarms 82  
   Blocking 58, 83  
   deviation 82  
   Display 59  
   Hysteresis 58, 83  
   Latching 58, 83  
   Logic 58  
   process 82  
   set points 82  
   Sides 58  
   Silencing 59, 83  
   Source 57  
   Type 57  
 Alarm Type 82  
 Altitude Units 43  
 Analog Input Menu 34, 45  
 Assembly Definition Addresses 93

Assembly Definition Addresses 86  
 Assembly Definition Addresses and Assembly Working Addresses 93  
 Assembly Working Addresses 86, 93  
 Attention Codes 28  
 auto (closed loop) control 79  
 Autotune 74  
 Autotune Aggressiveness 52, 53  
 Autotune Request 37  
 Autotune Set Point 37, 74  
 autotuning 74–75  
 autotuning with TRU-TUNE+™ 75

## B

Baud Rate 62  
 Blocking 58, 83  
 bumpless transfer 79

## C

calibrating an analog input 76  
 Calibration Menu 71  
 Calibration Offset 34, 57, 76–77  
 changing the set point 28  
 Channel 62  
 chattering output 80  
 chemical compatibility 13  
 CIP (Common Industrial Protocol) 31  
 Closed Loop Set Point 37  
 Closed Loop Working Set Point 36  
 Communications Menu 62, 63, 65, 69  
   Setup Page 33, 43  
 Control 50, 55  
 Control Loop Menu 52  
 control methods 79  
 Control Mode 37, 79  
 Control Mode Active 36  
 Control Module Menus  
   Factory Page  
     Calibration Menu 71  
     Security Setting Menu 69, 71  
   Operations Page  
     Alarm Menu 39  
     Analog Input Menu 34  
     Digital Input/Output Menu 36  
     Linearization Menu 34  
     Loop Menu 37  
     Monitor Menu 36  
     Process Value Menu 35  
     Profile Status Menu 40  
   Setup Page  
     Alarm Menu 57  
     Analog Input Menu 45  
     Communications Menu 62, 63, 65, 69  
     Control Loop Menu 52  
     Digital Input/Output Menu 49

- Global Menu 60
- Linearization Menu 46
- Output Menu 55
- Process Value 48
- Cool Algorithm 52, 80
- Cool Hysteresis 38, 80
- Cool Output Curve 52, 79
- Cool Power 36, 75
- Cool Proportional Band 38, 75, 80
- Custom Menu 74

## D

- Data Map 32, 63
- Date of Manufacture 71
- dead band 81
- Dead Band 38, 81
- Decimal 46
- default Home Page parameters 26, 28
- deviation alarms 82
- Digital Input Function 60
- Digital Input/Output Menu 36, 49
- dimensions 9, 11
  - 1/16 DIN 8
- Direction 49
- Display 59
- Display Pairs 44, 62
- displays 26
- Display Time 62
- Display Units 60
- Down Key 26

## E

- Electrical Gain 76
- Electrical Input Offset 72, 76
- Electrical Input Slope 72, 76
- Electrical Measurement 71, 76
- Electrical Output Offset 72
- Electrical Output Slope 72
- End Set Point Value 67
- Event Output (1 and 2) 67
- EZ Key 84

## F

- Factory Page 68
- Filter Time 46, 77
- filter time constant 77
- Function 43, 75
- Function Instance 50, 52
- Function Key Menu 84

## G

- Global Menu 60
  - Setup Page 33, 43
- Guaranteed Soak Deviation 44
- Guaranteed Soak Deviation 61
- Guaranteed Soak Enable 44, 61

## H

- Heat Algorithm 52, 80

- Heat Hysteresis 37, 80
- Heat Power 36, 75
- Heat Proportional Band 37, 75, 80
- High Power Scale 50, 56
- high range 77
- high scale 77
- High Set Point
  - Alarm 39, 40, 83
  - Loop 54, 77
- Home Page 28, 74
- Hours 65
- Hysteresis 58, 83

## I

- Idle Set Point 37
- Input Error Failure 53, 79
- Input Error Latching 46, 79
- Input Error Status 34
- input events 4
- input features 76–78
  - calibration 76
- Input Point 1 43
- Input Point 2 43
- Input Point 3 43
- Input Point 4 43
- Input Point 5 43
- Input Point 6 43
- Input Point 7 43
- Input Point 8 43
- Input Point 9 43
- Input Point 10 43
- inputs 4
- Input Sensor Type 75
- installation 12
- Instance 60
- IP Fixed Address Part 4 61, 62

## J

- Jump Count 67
- Jump Count Remaining 42
- Jump Step 66

## K

- keys and displays
  - 1/16 DIN 26

## L

- Latching 58, 83
- Level 59
- Linearization 32, 45
- Linearization Menu 34, 46
- Locked Access Level 68, 70
- Lock Operations Page 84
- Lockout Menu 84
- Lock Profiling Page 84
- Logic 58
- Loop Menu 37
- Low Power Scale 50, 55
- low range 77
- low scale 77
- Low Set Point

- Alarm 39, 83
- Loop 54, 77

## M

- Manual Control Indicator Light 79
- manual (open loop) control 79
- manual tuning 75
- Message Action 27
- message, display 27
- Minutes 65, 66
- Modbus Default Assembly Structure 80-119 94
- Modbus - Programmable Memory Blocks 93
- Modbus Word Order 63
- Monitor Menu 36

## N

- navigating
  - Factory Page 68
  - pages and menus 30
  - Profiling Page 64
  - Setup Page 33, 43
- network wiring 23
- no-arc relay 78
- Non-volatile Save 44

## O

- on-off control 80
- Open Loop Detect Deviation 54
- Open Loop Detect Enable 53
- Open Loop Detection 83
- Open Loop Detect Time 53
- Open Loop Set Point 38
- Operations Page 33
- output configuration 79
- output features 77
- Output Function 56, 78
- Output Menu 55
- Output Point 1 43
- Output Point 2 43
- Output Point 3 43
- Output Point 4 43
- Output Point 5 43
- Output Point 6 43
- Output Point 7 43
- Output Point 8 43
- Output Point 9 43
- Output Point 10 43
- output power scaling 78
- outputs 4
- Output State 36
- Output Type 56, 78

## P

- P3T armor sealing system 3
- Parameter 1 to 20 69
- Parameter ID 31
- Parity 63
- Part Number 71
- Password 71

- Password Enable 68
- Peltier Delay 43, 53
- Power Out Time 44, 61
- Pressure Units 43
- process alarms 82
- Process Error Enable 46
- Process Error Low 46
- Process Value 34, 48
- Process Value Active 36
- Process Value Menu 35
- Profibus 32
- Profibus Index 31
- Profile Status Menu 40
- Profile Type 61
- Profiling Page 64
- profiling parameters 64
- programming the Home Page 74
- proportional control 80
  - plus integral (PI) control 80
  - plus integral plus derivative (PID) control 81
- Protocol 62
- Public Key 68, 71

## Q

## R

- Ramp Action 54
- Ramp Rate 54, 82
- Ramp Scale 54, 82
- Range High 46, 57, 77
- Range Low 45, 56, 77
- Read Lockout Security 84
- Real Time Clock 32, 44
- Relative Humidity 47
- Relative Temperature 47
- Remote Enable 37
- removing mounted controller 12
- responding to a displayed message 27–28
- restoring user settings 74
- retransmit 77
- Retransmit Source 56, 78
- Rolling Password 68, 70
- RTD Leads 45

## S

- saving user settings 74
- Scale High 45, 56, 77, 78
- Scale Low 45, 56, 77, 78
- Seconds 65
- secure settings 84, 85
- Security Setting 69, 71
- sensor selection 77
- Sensor Type 45, 75, 77
- Serial Number 71
- Set Lockout Security 84
- set point high limit 77
- Set Point High Limit Open Loop 54

- set point low limit 77
- Set Point Low Limit Open Loop 54
- Setup Page 43
- Sides
  - Alarm 58
- Silencing 59, 83
- single set point ramping 82
- Software Build 71
- Software Revision 71
- Source 57
- System Security 85

## T

- Target Set Point 65
- temperature units indicator lights 26
- Thermistor 18, 45
- Time Base 50, 55
- Time Derivative 38, 75, 81
- Time Integral 38, 75, 80
- TRU-TUNE+™ Band 52, 75
- TRU-TUNE+™ Enable 52, 75
- TRU-TUNE+™ Gain 52, 75
- tuning the PID parameters 74
- Type 57

## U

- upper display 26
- User Failure Action 53
- User Password 68, 70
- User Restore Set 62, 74
- User Save Set 62, 74
- User Tune Aggressiveness 74
- Using EZ-ZONE® Configurator Software 87
- using the software 84

## V

- variable time base 81

## W

- Wait Event (1 and 2) 66
- Wait For Process Instance 66
- Wait For Time 65
- weight 96
- wiring
  - digital input or output 5 16
  - high power 16
  - input 1 potentiometer 17
  - input 1 process 17
  - input 1 RTD 17
  - input 1 thermocouple 17
  - input 2 thermocouple 18
  - low power 16
  - Modbus RTU or Standard Bus EIA-485 communications 23
  - output 1 mechanical relay, form C 20
  - output 1 solid-state relay, form A 21

- output 1 switched dc/open collector 19, 20
- output 1 universal process 20
- output 2 mechanical relay, form A 22
- output 2 no-arc relay, form A 22
- output 2 solid-state relay, form A 22
- output 2 switched DC/open collector 21
- output 3 switched dc/open collector 23
- Standard Bus EIA-485 communications 23

## X

## Y

## Z

- Zone Display 62



# Declaration of Conformity

## Series EZ-ZONE® PM



WATLOW  
1241 Bundy Blvd.  
Winona, MN 55987 USA

an ISO 9001 approved facility since 1996.

Declares that the following product:

Designation: **Series EZ-ZONE® PM (Panel Mount)**

Model Numbers: PM (3, 6, 8, 9 or 4)(Any Letter or number) – (1, 2, 3 or 4)(A, C, E, F or K) (A, C, H, J or K)(Any letter or number) – (Any letter or number)(A, C, E, F or K)(A, C, H, J or K) (Any three letters or numbers)

Classification: Temperature control, Installation Category II, Pollution degree 2, IP66

Rated Voltage and Frequency: 100 to 240 V~ (ac 50/60 Hz) or 15 to 36 V= dc/ 24 V~ac 50/60 Hz

Rated Power Consumption: 10 VA maximum PM3, PM6 Models.  
14 VA maximum PM8, PM9, PM4 Models

Meets the essential requirements of the following European Union Directives by using the relevant standards show below to indicate compliance.

### **2004/108/EC Electromagnetic Compatibility Directive**

<b>EN 61326-1</b>	<b>2006</b>	<b>Electrical equipment for measurement, control and laboratory use – EMC requirements (Industrial Immunity, Class B Emissions).</b>
EN 61000-4-2	1996 +A1,A2	Electrostatic Discharge Immunity
EN 61000-4-3	2006	Radiated Field Immunity 10V/M 80–1000 MHz, 3 V/M 1.4–2.7 GHz
EN 61000-4-4	2004	Electrical Fast-Transient / Burst Immunity
EN 61000-4-5	2006	Surge Immunity
EN 61000-4-6	1996 +A1,A2,A3	Conducted Immunity
EN 61000-4-11	2004	Voltage Dips, Short Interruptions and Voltage Variations Immunity
EN 61000-3-2	2006	Harmonic Current Emissions
EN 61000-3-3 <sup>1</sup>	2005	Voltage Fluctuations and Flicker
SEMI F47	2000	Specification for Semiconductor Sag Immunity Figure R1-1

<sup>1</sup>For mechanical relay loads, cycle time may need to be extended up to 160 seconds to meet flicker requirements depending on load switched and source impedance.

### **2006/95/EC Low-Voltage Directive**

<b>EN 61010-1</b>	<b>2001</b>	<b>Safety Requirements of electrical equipment for measurement, control and laboratory use. Part 1: General requirements</b>
-------------------	-------------	--

### **Compliant with 2002/95/EC RoHS Directive**

Per 2002/96/EC W.E.E Directive  Please Recycle Properly.

Raymond D. Feller III  
Name of Authorized Representative

Winona, Minnesota, USA  
Place of Issue

General Manager  
Title of Authorized Representative

June 2009  
Date of Issue

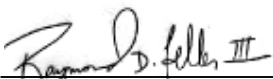
  
Signature of Authorized Representative

CE DOC EZ-ZONE PM-06-09

# How to Reach Us

## Corporate Headquarters

Watlow Electric Manufacturing Company  
12001 Lackland Road  
St. Louis, MO 63146  
Sales: 1-800-WATLOW2  
Manufacturing Support: 1-800-4WATLOW  
Email: [info@watlow.com](mailto:info@watlow.com)  
Website: [www.watlow.com](http://www.watlow.com)  
From outside the USA and Canada:  
Tel: +1 (314) 878-4600  
Fax: +1 (314) 878-6814

## Latin America

Watlow de México S.A. de C.V.  
Av. Fundación No. 5  
Col. Parques Industriales  
Querétaro, Qro. CP-76130  
Mexico  
Tel: +52 442 217-6235  
Fax: +52 442 217-6403

## Asia and Pacific

Watlow Singapore Pte Ltd.  
16 Ayer Rajah Crescent,  
#06-03/04,  
Singapore 139965  
Tel: +65 6773 9488 Fax: +65 6778 0323  
Email: [info@watlow.com.sg](mailto:info@watlow.com.sg) Website: [www.watlow.com.sg](http://www.watlow.com.sg)

Watlow Australia Pty., Ltd.  
4/57 Sharps Road  
Tullamarine, VIC 3043  
Australia  
Tel: +61 3 9335 6449  
Fax: +61 3 9330 3566  
Website: [www.watlow.com](http://www.watlow.com)

Watlow Electric Manufacturing (Shanghai) Company  
1118 Fangyuan Road, Anting Industrial Park, Jiading, Shanghai,  
PRC 201203  
People's Republic of China  
Tel: +86 21 39509510  
Fax: +86 21 5080-0906  
Email: [info@watlow.cn](mailto:info@watlow.cn)  
Website: [www.watlow.cn](http://www.watlow.cn)

ワトロー ジャパン株式会社  
〒101-0047 東京都千代田区内神田1-14-4  
四国ビル別館9階  
Tel: 03-3518-6630 Fax: 03-3518-6632  
Email: [infoj@watlow.com](mailto:infoj@watlow.com) Website: [www.watlow.co.jp](http://www.watlow.co.jp)

Watlow Japan Ltd.  
1-14-4 Uchikanda, Chiyoda-Ku  
Tokyo 101-0047  
Japan  
Tel: +81-3-3518-6630 Fax: +81-3-3518-6632  
Email: [infoj@watlow.com](mailto:infoj@watlow.com) Website: [www.watlow.co.jp](http://www.watlow.co.jp)

## Europe

Watlow France  
Tour d'Asnières.  
4 Avenue Laurent Cély  
92600 Asnières sur Seine  
France  
Tél: + 33 (0)1 41 32 79 70  
Télécopie: + 33(0)1 47 33 36 57  
Email: [info@watlow.fr](mailto:info@watlow.fr)  
Website: [www.watlow.fr](http://www.watlow.fr)

Watlow GmbH  
Postfach 11 65, Lauchwasenstr. 1  
D-76709 Kronau  
Germany  
Tel: +49 (0) 7253 9400-0  
Fax: +49 (0) 7253 9400-900  
Email: [info@watlow.de](mailto:info@watlow.de)  
Website: [www.watlow.de](http://www.watlow.de)

Watlow Italy S.r.l.  
Viale Italia 52/54  
20094 Corsico MI  
Italy  
Tel: +39 024588841  
Fax: +39 0245869954  
Email: [italyinfo@watlow.com](mailto:italyinfo@watlow.com)  
Website: [www.watlow.it](http://www.watlow.it)

Watlow Ibérica, S.L.U.  
C/Marte 12, Posterior, Local 9  
E-28850 Torrejón de Ardoz  
Madrid - Spain  
T. +34 91 675 12 92  
F. +34 91 648 73 80  
Email: [info@watlow.es](mailto:info@watlow.es)  
Website: [www.watlow.es](http://www.watlow.es)

Watlow UK Ltd.  
Linby Industrial Estate  
Linby, Nottingham, NG15 8AA  
United Kingdom  
Telephone: (0) 115 964 0777  
Fax: (0) 115 964 0071  
Email: [info@watlow.co.uk](mailto:info@watlow.co.uk)  
Website: [www.watlow.co.uk](http://www.watlow.co.uk)  
From outside The United Kingdom:  
Tel: +44 115 964 0777  
Fax: +44 115 964 0071

Watlow Korea Co., Ltd.  
#1406, E&C Dream Tower, 46, Yangpyeongdong-3ga  
Yeongdeungpo-gu, Seoul 150-103  
Republic of Korea  
Tel: +82 (2) 2628-5770 Fax: +82 (2) 2628-5771  
Website: [www.watlow.co.kr](http://www.watlow.co.kr)

Watlow Malaysia Sdn Bhd  
No. 14-3 Jalan 2/114  
Kuchai Business Centre  
Jalan Kuchai Lama  
58200 Kuala Lumpur  
Malaysia  
Tel: +60 3 7980 7741 Fax: +60 3 7980 7739

瓦特龍電機股份有限公司  
80143 高雄市前金區七賢二路189號 10樓之一  
電話: 07-2885168 傳真: 07-2885568

Watlow Electric Taiwan Corporation  
10F-1 No.189 Chi-Shen 2nd Road Kaohsiung 80143  
Taiwan  
Tel: +886-7-2885168 Fax: +886-7-2885568

**Your Authorized Watlow Distributor**

